



AV Receiver

# VSX-1124-K

Register your product on

<http://www.pioneerelectronics.com> (US)

<http://www.pioneerelectronics.ca> (Canada)

- **Protect your new investment**

The details of your purchase will be on file for reference in the event of an insurance claim such as loss or theft.

- **Receive free tips, updates and service bulletins on your new product**

- **Improve product development**

Your input helps us continue to design products that meet your needs.

- **Receive a free Pioneer newsletter**

Registered customers can opt in to receive a monthly newsletter.

Operating Instructions

## IMPORTANT



The lightning flash with arrowhead symbol, within an equilateral triangle, is intended to alert the user to the presence of uninsulated "dangerous voltage" within the product's enclosure that may be of sufficient magnitude to constitute a risk of electric shock to persons.

### CAUTION

**RISK OF ELECTRIC SHOCK  
DO NOT OPEN**



The exclamation point within an equilateral triangle is intended to alert the user to the presence of important operating and maintenance (servicing) instructions in the literature accompanying the appliance.

D3 4 2 1 1b\_A1\_En

### WARNING

This equipment is not waterproof. To prevent a fire or shock hazard, do not place any container filled with liquid near this equipment (such as a vase or flower pot) or expose it to dripping, splashing, rain or moisture.

D3 4 2 1 3\_A1\_En

### WARNING

To prevent a fire hazard, do not place any naked flame sources (such as a lighted candle) on the equipment.

D3 4 2 1 7a\_A1\_En

### VENTILATION CAUTION

When installing this unit, make sure to leave space around the unit for ventilation to improve heat radiation (at least 40 cm at top, 10 cm at rear, and 20 cm at each side).

### WARNING

Slots and openings in the cabinet are provided for ventilation to ensure reliable operation of the product, and to protect it from overheating. To prevent fire hazard, the openings should never be blocked or covered with items (such as newspapers, table cloths, curtains) or by operating the equipment on thick carpet or a bed.

D3 4 2 1 7b\*\_A1\_En

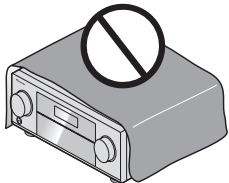

### Operating Environment

Operating environment temperature and humidity:  
+5 °C to +35 °C (+41 °F to +95 °F); less than 85 %RH (cooling vents not blocked)

Do not install this unit in a poorly ventilated area, or in locations exposed to high humidity or direct sunlight (or strong artificial light).

D3 4 2 1 7c\*\_A2\_En

### CAUTION

The **STANDBY/ON** switch on this unit will not completely shut off all power from the AC outlet. Since the power cord serves as the main disconnect device for the unit, you will need to unplug it from the AC outlet to shut down all power. Therefore, make sure the unit has been installed so that the power cord can be easily unplugged from the AC outlet in case of an accident. To avoid fire hazard, the power cord should also be unplugged from the AC outlet when left unused for a long period of time (for example, when on vacation).

D3 4 2 2 2a\*\_A1\_En

## IMPORTANT SAFETY INSTRUCTIONS

- 1) Read these instructions.
- 2) Keep these instructions.
- 3) Heed all warnings.
- 4) Follow all instructions.
- 5) Do not use this apparatus near water.
- 6) Clean only with dry cloth.
- 7) Do not block any ventilation openings. Install in accordance with the manufacturer's instructions.
- 8) Do not install near any heat sources such as radiators, heat registers, stoves, or other apparatus (including amplifiers) that produce heat.
- 9) Do not defeat the safety purpose of the polarized or grounding type plug. A polarized plug has two blades with one wider than the other. A grounding type plug has two blades and a third grounding prong. The wide blade or the third prong are provided for your safety. If the provided plug does not fit into your outlet, consult an electrician for replacement of the obsolete outlet.
- 10) Protect the power cord from being walked on or pinched particularly at plugs, convenience receptacles, and the point where they exit from the apparatus.

- 11) Only use attachments/accessories specified by the manufacturer.
- 12) Use only with the cart, stand, tripod, bracket, or table specified by the manufacturer, or sold with the apparatus. When a cart is used, use caution when moving the cart/apparatus combination to avoid injury from tip over.



- 13) Unplug this apparatus during lightning storms or when unused for long periods of time.
- 14) Refer all servicing to qualified service personnel. Servicing is required when the apparatus has been damaged in any way, such as power supply cord or plug is damaged, liquid has been spilled or objects have fallen into the apparatus, the apparatus has been exposed to rain or moisture, does not operate normally, or has been dropped.

D3 7 13 69\_En

### NOTE:

This equipment has been tested and found to comply with the limits for a Class B digital device, pursuant to Part 15 of the FCC Rules. These limits are designed to provide reasonable protection against harmful interference in a residential installation. This equipment generates, uses, and can radiate radio frequency energy and, if not installed and used in accordance with the instructions, may cause harmful interference to radio communications. However, there is no guarantee that interference will not occur in a particular installation. If this equipment does cause harmful interference to radio or television reception, which can be determined by turning the equipment off and on, the user is encouraged to try to correct the interference by one or more of the following measures:

Reorient or relocate the receiving antenna.

Increase the separation between the equipment and receiver.

Connect the equipment into an outlet on a circuit different from that to which the receiver is connected.

Consult the dealer or an experienced radio/TV technician for help.

D8 10 1 2\_A1\_En

### Caution

To prevent fire hazard, the Class 2 Wiring Cable should be used for connection with speaker, and should be routed away from hazards to avoid damage to the insulation of the cable.

D3 7 13 67\*\_A1\_En

**WARNING:** Handling the cord on this product or cords associated with accessories sold with the product may expose you to chemicals listed on proposition 65 known to the State of California and other governmental entities to cause cancer and birth defect or other reproductive harm.

**Wash hands after handling.**

D36 P5\_B1\_En

### Information to User

Alterations or modifications carried out without appropriate authorization may invalidate the user's right to operate the equipment.

D8 10 2\_A1\_En

**IMPORTANT NOTICE**

THE MODEL NUMBER AND SERIAL NUMBER OF THIS EQUIPMENT ARE ON THE REAR OR BOTTOM. RECORD THESE NUMBERS ON YOUR ENCLOSED WARRANTY CARD AND KEEP IN A SAFE PLACE FOR FUTURE REFERENCE.

D36 AP9 1\_A1\_En

**CAUTION**

This product satisfies FCC regulations when shielded cables and connectors are used to connect the unit to other equipment. To prevent electromagnetic interference with electric appliances such as radios and televisions, use shielded cables and connectors for connections.

D8 10 3a\_A1\_En

This product is for general household purposes. Any failure due to use for other than household purposes (such as long term use for business purposes in a restaurant or use in a car or ship) and which requires repair will be charged for even during the warranty period.

K041\_A1\_En

**WARNING**

Store small parts out of the reach of children and infants. If accidentally swallowed, contact a doctor immediately.

D41 6 4\_A1\_En

**The Safety of Your Ears is in Your Hands**

Get the most out of your equipment by playing it at a safe level – a level that lets the sound come through clearly without annoying blaring or distortion and, most importantly, without affecting your sensitive hearing. Sound can be deceiving. Over time, your hearing “comfort level” adapts to higher volumes of sound, so what sounds “normal” can actually be loud and harmful to your hearing. Guard against this by setting your equipment at a safe level BEFORE your hearing adapts.

**ESTABLISH A SAFE LEVEL:**

- Set your volume control at a low setting.
- Slowly increase the sound until you can hear it comfortably and clearly, without distortion.
- Once you have established a comfortable sound level, set the dial and leave it there.

**BE SURE TO OBSERVE THE FOLLOWING GUIDELINES:**

- Do not turn up the volume so high that you can't hear what's around you.
- Use caution or temporarily discontinue use in potentially hazardous situations.
- Do not use headphones while operating a motorized vehicle; the use of headphones may create a traffic hazard and is illegal in many areas.

S001a\_A1\_En

Thank you for buying this Pioneer product. Please read through these operating instructions so you will know how to operate your model properly.

# Contents

## 01 Before you start

Features .....	8
Checking what's in the box.....	10
Installing the receiver.....	10
Loading the batteries.....	10
Operating range of remote control unit.....	11

## 02 Controls and displays

Remote control .....	13
Display .....	15
Front panel .....	16

## 03 Connecting your equipment

Connecting your equipment.....	18
Rear panel .....	18
Determining the speakers' application .....	19
Placing the speakers.....	21
Connecting the speakers.....	21
Installing your speaker system.....	22
Selecting the Speaker system .....	23
About the audio connection .....	23
About the video converter .....	24
About HDMI .....	24
Connecting your TV and playback components .....	25
Connecting a satellite/cable receiver or other set-top box .....	27
Connecting other audio components.....	28
Connecting additional amplifiers.....	29
Connecting AM/FM antennas .....	29
MULTI-ZONE setup.....	30
Connecting to the network through LAN interface .....	32
Connecting optional <i>Bluetooth</i> ADAPTER .....	33
Connecting an iPod.....	33
Connecting a USB device.....	33
Connecting an MHL-compatible device.....	34
Connecting an HDMI-equipped component to the front panel input .....	34
Connecting to a wireless LAN .....	34
Connecting an IR receiver .....	35
Plugging in the receiver.....	35

## 04 Basic Setup

How to use the built-in AVNavigator.....	37
Automatically conducting optimum sound tuning (Full Auto MCACC) .....	38
The Input Setup menu.....	40
Operation Mode Setup.....	41
Changing the OSD display language (OSD Language).....	41
About the Home Menu.....	42

## 05 Basic playback

Playing a source .....	44
Playing an iPod .....	45
Playing a USB device .....	46
Playing an MHL-compatible device .....	47
Listening to the radio.....	48
<i>Bluetooth</i> ADAPTER for Wireless Enjoyment of Music .....	49

## 06 Listening to your system

Enjoying various types of playback using the listening modes.....	52
Selecting MCACC presets .....	54
Choosing the input signal.....	54
Better sound using Phase Control.....	54

## 07 Playback with NETWORK features

Introduction.....	56
Playback with Network functions.....	57
About network playback.....	60
About playable file formats.....	61

## 08 Control with HDMI function

About the Control with HDMI function.....	63
Making Control with HDMI connections.....	63
HDMI Setup.....	63
Before using synchronization.....	64
About synchronized operations .....	64
Setting the PQLS function .....	64
About Sound Retriever Link and Stream Smoother Link.....	64
Cautions on the Control with HDMI function .....	65

## 09 Using other functions

Setting the Audio options .....	67
Setting the Video options.....	69
Switching the output (OUTPUT PARAMETER).....	71
Changing the channel level while listening .....	71
Using the MULTI-ZONE controls.....	72
Network settings from a web browser.....	73
Using the sleep timer .....	73
Dimming the display .....	73
Checking your system settings .....	73
Resetting the system.....	74

## 10 Controlling the rest of your system

About the Remote Setup menu.....	76
Operating multiple receivers.....	76
Setting the remote to control other components.....	76
Selecting preset codes directly.....	76
Programming signals from other remote controls.....	77
Erasing one of the remote control button settings.....	77
Erasing all learnt settings that are in one input function.....	78
Using All Zone Standby.....	78
Setting the switching time of AV amplifier operation mode.....	78
Resetting the remote control settings.....	78
Controlling components.....	79

## 11 The Advanced MCACC menu

Making receiver settings from the Advanced MCACC menu.....	82
Automatic MCACC (Expert).....	82
Manual MCACC setup.....	84
Checking MCACC Data.....	86
Data Management.....	87

## 12 The System Setup and Other Setup menus

Making receiver settings from the System Setup menu.....	89
Manual speaker setup.....	89
Network Setup menu.....	91
Checking the Network Information.....	92
MHL Setup.....	92
The Other Setup menu.....	92
Making network settings using Safari.....	95
Using Safari to set a friendly name.....	95
Using Safari to update the firmware.....	96

## 13 FAQ

Troubleshooting.....	98
Power.....	98
No sound.....	98
Other audio problems.....	99
ADAPTER PORT terminal.....	100
Video.....	100
Settings.....	101
Professional Calibration EQ graphical output.....	101
Display.....	101
Remote control.....	102
HDMI.....	102
MHL.....	103
Built-in AVNavigator.....	103
USB interface.....	104
iPod.....	104
Network.....	104
Wireless LAN.....	107

## 14 Additional information

Surround sound formats.....	109
SABRE DAC™.....	109
About HDMI.....	109
HTC Connect.....	109
About iPod.....	110
Windows 8.....	110
MHL.....	110
Software license notice.....	110
Auto Surround, ALC and Stream Direct with different input signal formats.....	111
Speaker Setting Guide.....	111
About messages displayed when using network functions.....	112
Important information regarding the HDMI connection.....	113
Cleaning the unit.....	113
Glossary.....	113
Features index.....	116
Specifications.....	117
Preset code list.....	118

# Flow of settings on the receiver

## Flow for connecting and setting the receiver

The unit is a full-fledged AV receiver equipped with an abundance of functions and terminals. It can be used easily after following the procedure below to make the connections and settings.

**Required setting item:** 1, 2, 3, 4, 5, 8, 10

**Setting to be made as necessary:** 6, 7, 9, 11, 12, 13



### Important

Using **Wiring Navi** on AVNavigator of this receiver, you can make the initial settings of the receiver on your computer or mobile device. In that case, you can use **Wiring Navi** to make the same connections or settings that are performed in Steps 2, 3, 4, 5, 6, 8, and 9. For details of how to use AVNavigator, refer to [How to use the built-in AVNavigator](#) on [page 37](#).

### 1 Before you start

- [Checking what's in the box](#) on [page 10](#)
- [Loading the batteries](#) on [page 10](#)



### 2 Determining the speakers' application ([page 19](#))

- 7.2 channel surround system (Front height)
- 7.2 channel surround system (Front wide)
- 7.2 channel surround system & Speaker B connection
- 5.2 channel surround system & Front Bi-amping connection (High quality surround)
- 5.2 channel surround system & ZONE 2 connection (Multi Zone)
- 5.2 channel surround system & HDZONE connection (Multi Zone)



### 3 Connecting the speakers

- [Placing the speakers](#) on [page 21](#)
- [Connecting the speakers](#) on [page 21](#)
- [Installing your speaker system](#) on [page 22](#)
- [Bi-amping your speakers](#) on [page 22](#)



### 4 Connecting the components

- [About the audio connection](#) on [page 23](#)
- [About the video converter](#) on [page 24](#)
- [Connecting your TV and playback components](#) on [page 25](#)
- [Connecting AM/FM antennas](#) on [page 29](#)
- [Plugging in the receiver](#) on [page 35](#)



### 5 Power On



### 6 Changing the OSD display language (OSD Language) ([page 41](#))



### 7 Using the AVNavigator functions ([page 37](#))



### 8 MCACC speaker settings

- [Automatically conducting optimum sound tuning \(Full Auto MCACC\)](#) on [page 38](#)



### 9 The Input Setup menu ([page 40](#))

*(When using connections other than the recommended connections)*



### 10 Basic playback ([page 43](#))



### 11 Adjusting the sound and picture quality as desired

- Using the various listening modes ([page 51](#))
- Better sound using Phase Control ([page 54](#))
- Measuring the all EQ type (SYMMETRY/ALL CH ADJ/FRONT ALIGN) ([page 82](#))
- Changing the channel level while listening ([page 90](#))
- Switching on/off the Acoustic Calibration EQ, Auto Sound Retriever or Dialog Enhancement ([page 67](#))
- Setting the PQLS function ([page 64](#))
- Setting the Audio options ([page 67](#))
- Setting the Video options ([page 69](#))



### 12 Other optional adjustments and settings

- Control with HDMI function ([page 62](#))
- The Advanced MCACC menu ([page 81](#))
- The System Setup and Other Setup menus ([page 88](#))



### 13 Making maximum use of the remote control

- Operating multiple receivers ([page 76](#))
- Setting the remote to control other components ([page 76](#))



## Before you start

Features .....	8
Checking what's in the box .....	10
Installing the receiver .....	10
Loading the batteries .....	10
Operating range of remote control unit.....	11



## Features

### Audio

- **ESS-24bit-DAC-equipped**

All channels are equipped with ESS SABRE Premier Audio DACs. The Jitter Eliminators achieve clearer sound.

- **Hi-bit 24 Audio Processing**

Creates a wider dynamic range with digital sources like CDs or DVDs. 16- and 20-bit PCM as well as compressed audio is requantized to 24 bits, and the high frequency component is interpolated upon data processing to enable smoother, more subtle musical expression.

- **Easy setup using Advanced MCACC**

The Auto MCACC Setup provides a quick but accurate surround sound setup, which includes the advanced features of Professional Acoustic Calibration EQ.

- **Auto Phase Control Plus**

For discs created with standards other than Phase Control, the LFE channel is delayed upon recording in the first place. This function automatically corrects phase shifting on such discs and broadcasts. This function is particularly effective when playing multi-channel music containing low frequency effects (LFE).

- **Phase Control**

Phase Control effectively eliminates phase lag, which makes the sound lack synchronization, and significantly improves the multi-channel sound without any extra operation.

- **PQLS Bit-stream**

Jitterless high quality playback is possible by connecting a PQLS-compatible player with HDMI connections. This feature is only available when the connected Pioneer Blu-ray Disc Player supports the PQLS function.

### Video

- **Ultra HD (with 4K/60p video support) - Pass-through and upscaling -**

Up to 4K/60p resolution images can be passed through and displayed as such, and the HD (High Definition) or Full HD images of DVDs, Blu-ray discs and HD broadcasts can be upscaled to a resolution of up to 4K/60p and displayed. A separate monitor supporting Ultra HD (4K video) is required.

- **HDMI (4K60p, 3D, Audio Return Channel)**

HDMI (4K60p, 3D, Audio Return Channel) - 7 in/2 out (As for 2 out; You can select 'Dual out' or 'HDZONE out') A compatible component is required to use the above function.

## Network

- **Roku Ready®**

This receiver is a certified Roku Ready® device. By just plugging the Roku Streaming Stick™ into the MHL port, you can enjoy the hottest movies, TV shows, music, games and more on your TV by streaming it directly from the Internet.

- **Spotify Digital Music-Streaming Service ready**

Spotify is a digital music-streaming service that gives you on-demand access to millions of songs. This receiver is ready for Connect from Spotify, which lets you select songs on your Spotify app to listen to on your audio system. For service availability in your country check [www.spotify.com](http://www.spotify.com).

- **Compatible with Windows 8.1**

This receiver is compatible with Windows 8.1, letting you easily stream music from compatible PCs on your home network.

- **Apple AirPlay**

With AirPlay you can stream music from iTunes to this receiver and play it through your home theater system. You can even use the receiver to view metadata including song titles, artist's names as well as the album art on a connected display. You can easily enjoy your iTunes music in any room in the house.

- **DLNA Certified (1.5)**

This receiver is a DLNA certified (1.5) device, enabled to work not only as a DMP (Digital Media Player) for playing DMS (Digital Media Server) audio files, but also as a DMR (Digital Media Renderer) to be controlled remotely by a device such as a smartphone or PC.

- **Internet Radio**

By connecting this receiver to the network via the LAN terminal, you can listen to Internet radio stations.

## Connectivity

- **Easy Network connection with the Wireless LAN converter**

With the AS-WL300 wireless LAN converter, you can enjoy using a wireless LAN connection for the AV receivers. The AS-WL300 works with the power supply from the AV receiver's dedicated USB terminal, so no AC adapter is required.

- **Bluetooth adapter ready**

Using the *Bluetooth* ADAPTER (AS-BT100 or AS-BT200) lets you enjoy music files on an iPhone or other Bluetooth wireless technology enabled device wirelessly.

- **MHL™ (Mobile High-definition Link)-compatible device playback**

An incorporates MHL 2 mobile device can be connected to enjoy 3D videos, full-HD videos, high quality multi-channel audio, and photos etc., with charge the battery on the receiver.

- **HTC Connect**

HTC Connect makes it easy to wirelessly stream your favorite music straight from your HTC phone. There's no need for a separate app; HTC Connect is built right in your phone's music player.

- **iPod Playback**

Your iPod and iPhone can be connected to the receiver's USB terminal to play the music files on the iPod or iPhone. Also, the iPod or iPhone is charged when it is connected to the receiver.





## Playback/Processing

- **Multi-channel Music File playback**

This receiver enables multi-channel music file playback with a resolution of up to 96 kHz/24 bit. Playback of WAV and FLAC files via the front USB port and network is supported.

- **DSD File Music playback (via Network, Front USB and HDMI)**

Playback of high sound quality DSD music (DSD files and DSD discs (SACDs)) is supported.

- **High Resolution Music Playback**

High resolution music files with resolutions of 96 kHz/24 bit to 192 kHz/24 bit can be played. Playback of AIFF, Apple Lossless, WAV and FLAC files via the front USB port and network is supported.

- **Gapless Playback**

The silent section between tracks is skipped when playing music files, eliminating the interruptions that usually occur when playing live or concert contents.

This receiver plays back AAC or MP3 format files with a minimum gap even though it is fundamentally impossible to play back without a gap.

- **Virtual Speakers**

By turning on the 'Virtual Surround Back', 'Virtual Height', and 'Virtual Wide' modes, it is possible to realize a maximum of 11.1 channels combining the speakers that are actually installed and the virtual speakers. This makes for a smoother connection between the sounds and an improved 3D feel.

- **dts Neo:X compatible**

This receiver supports the latest DTS processing format. The quality of Neo:X, originally designed for 9 channels or more, can be enjoyed in a 7-channel environment.

- **Dolby Pro Logic IIz compatible**

Adding a pair of speakers above the front left and right speakers adds expressiveness in the vertical direction to the previous horizontally-oriented sound field. The height channel strengthens the sound field's sense of three-dimensionality and air, producing presence and expansion.

## Installation

- **Built-in AVNavigator**

When accessing the receiver from the browser of your smartphone, tablet, Windows PC or Mac, you can use **Wiring Navi**, which explains how to connect or **Interactive Operation Guide**, which visually and intelligibly explains the operation method.

- **iControlAV5 Remote Application**

This is an application that allows intuitive operation of many of the receiver's functions. This application is available on the App Store for iPhone, iPod touch and iPad. You can also get it on Google Play for Android smartphones. The application can be downloaded free of charge.

- **HDZONE output**

This receiver supports output of the HDMI output to a subzone room. Powerful images can be enjoyed simply by connecting this receiver to a TV supporting 4K/Full-HD/3D. In addition, a multi-channel environment can be created by connecting this receiver to another AV receiver in the subzone room.

With HDZONE, you can select not only HDMI input but also **INTERNET RADIO** or **iPod/USB** and the like.

- **ZONE Ready**

This receiver is equipped with HDZONE and ZONE 2. HDZONE supports HD audio/video streaming to a separate room via HDMI. Multi-Zone enables music and movie playback from different sources in three zones at the same time.

- **Energy Saving Design**

This AV receiver has an ecological design. In addition to even lower power consumption in standby, the receiver is equipped with an 'eco mode' for low power consumption when playing contents as well. Furthermore, the eco mode can easily be set with a dedicated button on the remote control of using iControlAV5.



## Checking what's in the box

Please check that you've received the following supplied accessories:

- Setup microphone (cable: 5 m (16.4 ft.))
- Remote control unit
- AAA size IEC R03 dry cell batteries (to confirm system operation) x2
- AM loop antenna
- FM wire antenna
- CD-ROM
- Quick start guide
- Safety Brochure
- Warranty sheet

## Handling the CD-ROM

### Precautions For Use

- This CD-ROM is for use with a personal computer. It cannot be used with a DVD player or music CD player. Attempting to play this CD-ROM with a DVD player or music CD player can damage speakers or cause impaired hearing due to the large volume.

### License

- Please agree to the "Terms of Use" indicated below before using this CD-ROM. Do not use if you are unwilling to consent to the terms of its use.

### Terms of Use

- Copyright to data provided on this CD-ROM belongs to PIONEER HOME ELECTRONICS CORPORATION. Unauthorized transfer, duplication, broadcast, public transmission, translation, sales, lending or other such matters that go beyond the scope of "personal use" or "citation" as defined by Copyright Law may be subject to punitive actions. Permission to use this CD-ROM is granted under license by PIONEER HOME ELECTRONICS CORPORATION.

### General Disclaimer

- PIONEER HOME ELECTRONICS CORPORATION does not guarantee the operation of this CD-ROM with respect to personal computers using any of the applicable OS. In addition, PIONEER HOME ELECTRONICS CORPORATION is not liable for any damages incurred as a result of use of this CD-ROM and is not responsible for any compensation. The names of private corporations, products and other entities described herein are the registered trademarks or trademarks of their respective firms.

## Installing the receiver

- When installing this unit, make sure to put it on a level and stable surface.
- Don't install it on the following places:
  - on a color TV (the screen may distort)
  - near a cassette deck (or close to a device that gives off a magnetic field). This may interfere with the sound.
  - in direct sunlight
  - in damp or wet areas
  - in extremely hot or cold areas
  - in places where there is vibration or other movement
  - in places that are very dusty
  - in places that have hot fumes or oils (such as a kitchen)
- Do not touch this receiver's bottom panel while the power is on or just after it is turned off. The bottom panel becomes hot when the power is on (or right after it is turned off) and could cause burns.

## Loading the batteries

The batteries included with the unit are to check initial operations; they may not last over a long period. We recommend using alkaline batteries that have a longer life.

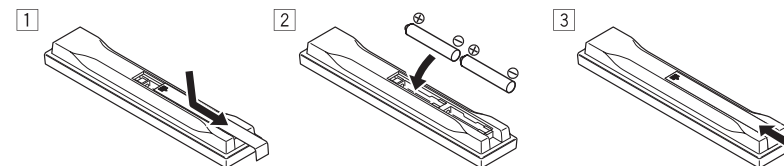

### WARNING

- Do not use or store batteries in direct sunlight or other excessively hot place, such as inside a car or near a heater. This can cause batteries to leak, overheat, explode or catch fire. It can also reduce the life or performance of batteries.

### CAUTION

Incorrect use of batteries may result in such hazards as leakage and bursting. Observe the following precautions:

- Never use new and old batteries together.
- Insert the plus and minus sides of the batteries properly according to the marks in the battery case.
- When inserting the batteries, make sure not to damage the springs on the battery's (-) terminals. This can cause batteries to leak or overheat.
- Batteries with the same shape may have different voltages. Do not use different batteries together.
- When disposing of used batteries, please comply with governmental regulations or environmental public institution's rules that apply in your country/area.

(Symbol examples for batteries)

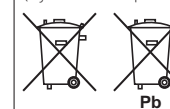

These symbols are only valid in the European Union.

K058c\_A1\_En



## Operating range of remote control unit

The remote control may not work properly if:

- There are obstacles between the remote control and the receiver's remote sensor.
- Direct sunlight or fluorescent light is shining onto the remote sensor.
- The receiver is located near a device that is emitting infrared rays.
- The receiver is operated simultaneously with another infrared remote control unit.

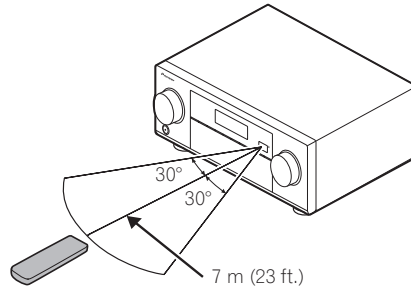



## Controls and displays

Remote control .....	13
Display .....	15
Front panel .....	16



## Remote control

This section explains how to operate the remote control for the receiver.

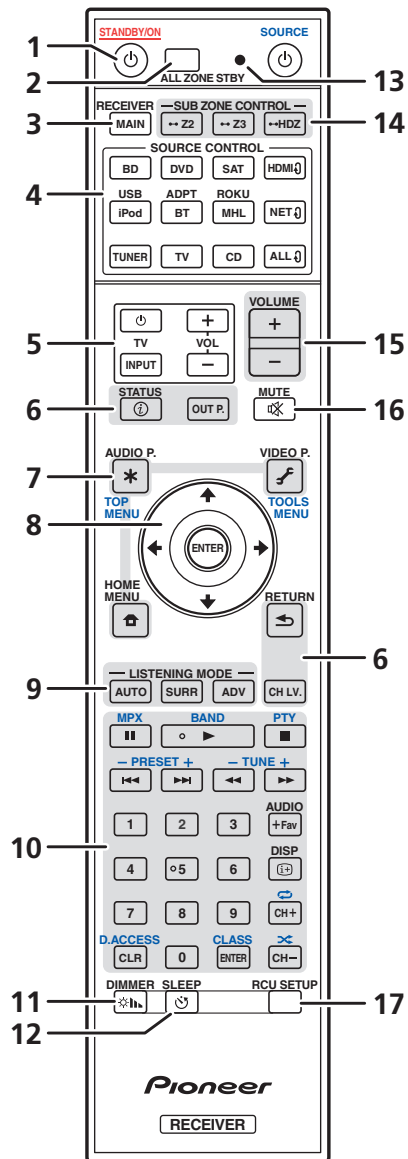

The remote has been conveniently color-coded according to component control using the following system:

- **White** – Receiver control, TV control
- **Blue** – Operation of other devices and each input (TUNER, etc.) (See pages 45, 46, 48, 49 and 79.)

### 1 STANDBY/ON

This switches between standby and on for this receiver.

### 2 ALL ZONE STBY

Use this button to perform unique operations (page 78).

### 3 MAIN RECEIVER

Switches the remote to control the receiver (used to select the white commands).

Switch to perform operations in the main zone.

### 4 SOURCE CONTROL buttons

Switches the input. Also, switches remote control operation mode for operating other devices or each input (TUNER, etc.) (page 76).

The input for **HDMI**, **NET** and **ALL** switches each time these buttons are pressed.

### 5 TV control buttons

These buttons can be used to perform operations on the TV to which the **TV INPUT** button is assigned. The TV can be operated with these buttons regardless of the input set for the remote control's operation mode (page 76).

### 6 Receiver Control buttons

- **STATUS** – Displays the IP address and information such as selected/set functions and input signals on the display (page 73).
- **OUT P.** (OUTPUT PARAMETER) – Switches the output terminal of the HDMI signal or speaker terminal to be played (page 71).
- **RETURN** – Press to confirm and exit the current menu screen.
- **CH LV.** (CHANNEL LEVEL) – Press repeatedly to select a channel, then use **←/→** to adjust the level (pages 71 and 90).

### 7 Receiver setting buttons

Press **MAIN RECEIVER** first to access:

- **AUDIO P.** (AUDIO PARAMETER) – Use to access the Audio options (page 67).
- **VIDEO P.** (VIDEO PARAMETER) – Use to access the Video options (page 69).
- **HOME MENU** – Use to access the Home Menu (pages 40, 41, 63, 82 and 89).

### 8 ↑/↓/←/→/ENTER

Use the arrow buttons when setting up your surround sound system (see page 82) and the Audio or Video options (page 67 or 69).

### 9 LISTENING MODE buttons

- **AUTO** (AUTO SURROUND/ALC/STREAM DIRECT) – Switches between Auto Surround (page 52), Auto Level Control mode and Stream Direct mode (page 53).
- **SURR** (STANDARD SURROUND) – Press for Standard decoding and to switch various modes (Pro Logic, Neo:X, etc.) (page 52).
- **ADV** (ADVANCED SURROUND) – Use to switch between the various surround modes (page 53).

### 10 Source device operation button

Operates other devices or each input (TUNER, etc.).

### 11 DIMMER

Dims or brightens the display (page 73).

### 12 SLEEP

Use to put the receiver in sleep mode and select the amount of time before sleep (page 73).



### 13 Remote control LED

Lights when a command is sent from the remote control.

### 14 SUB ZONE CONTROL buttons

- **Z2** (ZONE 2) – Holding down this button (for 1.5 seconds) until the remote control LED flashes one time, the mode changes to Zone 2 operation.
- **Z3** (ZONE 3) – It is not used with this receiver.
- **HDZ** (HDZONE) – Holding down this button (for 1.5 seconds) until the remote control LED flashes one time, the mode changes to HDZONE operation.

### 15 VOLUME +/-

Use to set the listening volume.

To adjust the main zone sound volume, press **MAIN RECEIVER** first and then press this button. When in the sub zone, press the **SUB ZONE CONTROL** button first and then press this button.

### 16 MUTE

Mutes the sound or restores the sound if it has been muted (adjusting the volume also restores the sound).

To mute the main zone sound volume, press **MAIN RECEIVER** first and then press this button. When in the sub zone, press the **SUB ZONE CONTROL** button first and then press this button.

### 17 RCU SETUP

Used to set the remote control ([page 76](#)).



## Display

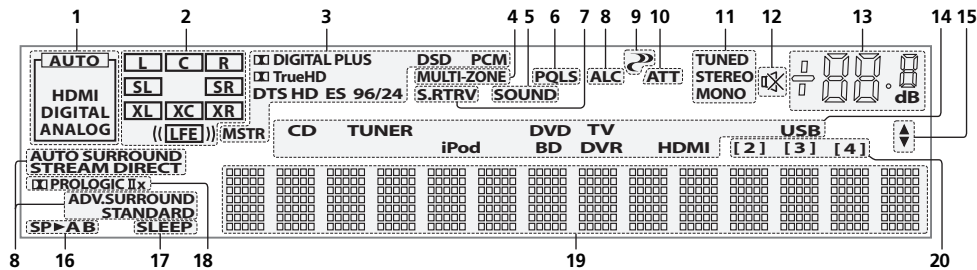

### 1 Signal indicators

Light to indicate the currently selected input signal. **AUTO** lights when the receiver is set to select the input signal automatically (page 54).

### 2 Program format indicators

Light to indicate the channels to which digital signals are being input.

- **L/R** – Left front/Right front channel
- **C** – Center channel
- **SL/SR** – Left surround/Right surround channel
- **LFE** – Low frequency effects channel (the (( )) indicators light when an LFE signal is being input)
- **XL/XR** – Two channels other than the ones above
- **XC** – Either one channel other than the ones above, the mono surround channel or matrix encode flag

### 3 Digital format indicators

Light when a signal encoded in the corresponding format is detected.

- **DIGITAL** – Lights with Dolby Digital decoding.
- **DIGITAL PLUS** – Lights with Dolby Digital Plus decoding.
- **TrueHD** – Lights with Dolby TrueHD decoding.
- **DTS** – Lights with DTS decoding.
- **DTS HD** – Lights with DTS-HD decoding.
- **96/24** – Lights with DTS 96/24 decoding.
- **DSD** – Lights during playback of DSD (Direct Stream Digital) signals.
- **DSD PCM** – Light during DSD (Direct Stream Digital) to PCM conversion.
- **PCM** – Lights during playback of PCM signals.
- **MSTR** – Lights during playback of DTS-HD Master Audio signals.

### 4 MULTI-ZONE

Lights when the MULTI-ZONE feature is active (page 72).

### 5 SOUND

Lights when the **DIALOG E** (Dialog Enhancement) or **TONE** (tone controls) features is selected (page 67).

### 6 PQLS

Lights when the PQLS feature is active (page 64).

### 7 S.RTRV

Lights when the Auto Sound Retriever function is active (page 67).

### 8 Listening mode indicators

- **ALC** – Lights when the ALC (Auto level control) mode is selected (page 52).
- **AUTO SURROUND** – Lights when the Auto Surround feature is switched on (page 52).
- **STREAM DIRECT** – Lights when Direct/Pure Direct is selected (page 53).
- **ADV.SURROUND** – Lights when one of the Advanced Surround modes has been selected (page 53).
- **STANDARD** – Lights when one of the Standard Surround modes is switched on (page 52).

### 9 (PHASE CONTROL)

Lights when the Phase Control is switched on (page 54).

### 10 ATT

Lights when the input signal level is lowered to reduce distortion (page 67).

### 11 Tuner indicators

- **TUNED** – Lights when a broadcast is being received.
- **STEREO** – Lights when a stereo FM broadcast is being received in auto stereo mode.
- **MONO** – Lights when the mono mode is set using **MPX**.

### 12 M

Lights when the sound is muted.

### 13 Master volume level

Shows the overall volume level.

"---" indicates the minimum level, and "+12dB" indicates the maximum level.

### 14 Input function indicators

Light to indicate the input function you have selected.

### 15 Scroll indicators

Light when there are more selectable items when making the various settings.

### 16 Speaker indicators

Lights to indicate the current speaker system using **OUT P**. (page 71).

### 17 SLEEP

Lights when the receiver is in sleep mode (page 73).

### 18 Matrix decoding format indicators

- **PRO LOGIC IIx** – This lights to indicate **II** Pro Logic II / **IIx** Pro Logic IIx decoding (page 52).

### 19 Character display

Displays various system information.

### 20 Remote control mode indicator

Lights to indicate the receiver's remote control mode setting. (Not displayed when set to **1**.) (page 93)



## Front panel

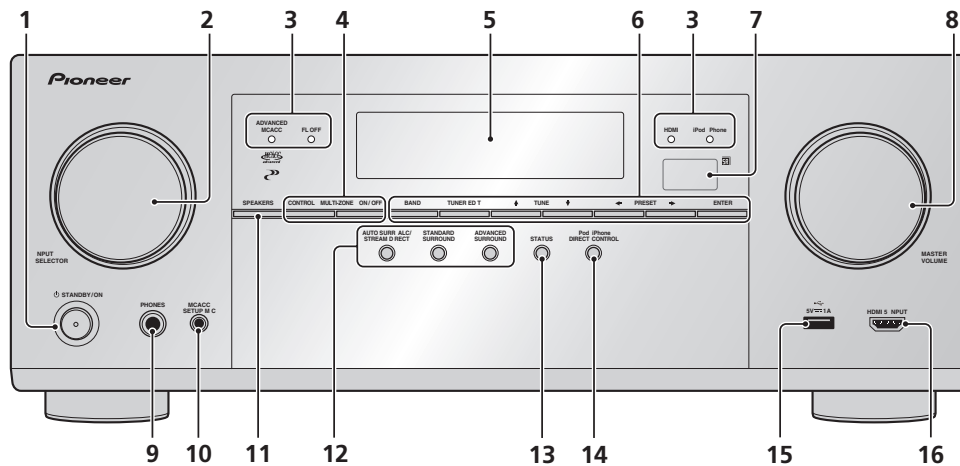

### 1 **STANDBY/ON**

This switches between standby and on for this receiver.

### 2 **INPUT SELECTOR dial**

Use to select an input function.

### 3 **Indicators**

- **ADVANCED MCACC** – Lights when **EQ** is set to **ON** in the **AUDIO PARAMETER** menu (page 67).
- **FL OFF** – Lights when "off" (nothing displayed) is selected with the display's dimmer adjustment (page 73).
- **HDMI** – Blinks when connecting an HDMI-equipped component; lights when the component is connected (page 25).
- **iPod iPhone** – Lights to indicate iPod/iPhone is connected (page 33).

### 4 **MULTI-ZONE controls**

If you've made MULTI-ZONE connections (page 30) use these controls to control the sub zone from the main zone (page 72).

### 5 **Character display**

See [Display](#) on page 15.

### 6 **TUNER controls**

- **BAND** – Switches between AM and FM radio bands (page 48).
- **TUNER EDIT** – Use with **TUNE** ↑/↓, **PRESET** ←/→ and **ENTER** to memorize and name stations for recall (page 48).
- **TUNE** ↑/↓ – Find radio frequencies (page 48).
- **PRESET** ←/→ – Find preset stations (page 48).

### 7 **Remote sensor**

Receives the signals from the remote control (page 11).

### 8 **MASTER VOLUME dial**

### 9 **PHONES jack**

Use to connect headphones. When the headphones are connected, there is no sound output from the speakers.

### 10 **MCACC SETUP MIC jack**

Use to connect the supplied microphone (page 38).

### 11 **SPEAKERS**

Use to change the speaker terminal (page 71).

### 12 **Listening mode buttons**

- **AUTO SURR/ALC/STREAM DIRECT** – Switches between Auto Surround (page 52), Auto Level Control and Stream Direct mode (page 53).
- **STANDARD SURROUND** – Press for Standard decoding and to switch various modes ( **PRO** Pro Logic, Neo:X, Stereo etc.) (page 52).
- **ADVANCED SURROUND** – Use to switch between the various surround modes (page 53).

### 13 **STATUS**

Displays the IP address and information such as selected/set functions and the input signal on the display (page 73).

### 14 **iPod iPhone DIRECT CONTROL**

Change the receiver's input to the iPod and enable iPod operations on the iPod (page 45).

### 15 **iPod/iPhone terminals**

Use to connect your Apple iPod/iPhone as an audio source (page 33), or connect a USB device for audio and photo playback (page 33).

### 16 **HDMI 5 INPUT terminal**

Use for connection to a compatible HDMI device (Video camera, etc.) (page 34).





## Connecting your equipment

Connecting your equipment.....	18
Rear panel .....	18
Determining the speakers' application.....	19
Placing the speakers.....	21
Connecting the speakers.....	21
Installing your speaker system.....	22
Selecting the Speaker system.....	23
About the audio connection.....	23
About the video converter .....	24
About HDMI .....	24
Connecting your TV and playback components .....	25
Connecting a satellite/cable receiver or other set-top box.....	27
Connecting other audio components .....	28
Connecting additional amplifiers.....	29
Connecting AM/FM antennas.....	29
MULTI-ZONE setup .....	30
Connecting to the network through LAN interface .....	32
Connecting optional <i>Bluetooth</i> ADAPTER.....	33
Connecting an iPod.....	33
Connecting a USB device .....	33
Connecting an MHL-compatible device.....	34
Connecting an HDMI-equipped component to the front panel input .....	34
Connecting to a wireless LAN.....	34
Connecting an IR receiver .....	35
Plugging in the receiver .....	35



## Connecting your equipment

This receiver provides you with many connection possibilities, but it doesn't have to be difficult. This chapter explains the kinds of components you can connect to make up your home theater system.

### CAUTION

- Before making or changing the connections, switch off the power and disconnect the power cord from the power outlet. Plugging in should be the final step.
- When making connections, also keep the power cords of the devices being connected unplugged from the power outlets.
- Depending on the device being connected (amplifier, receiver, etc.), the methods of connection and terminal names may differ from the explanations in this manual. Also refer to the operating instructions of the respective devices.

## Rear panel

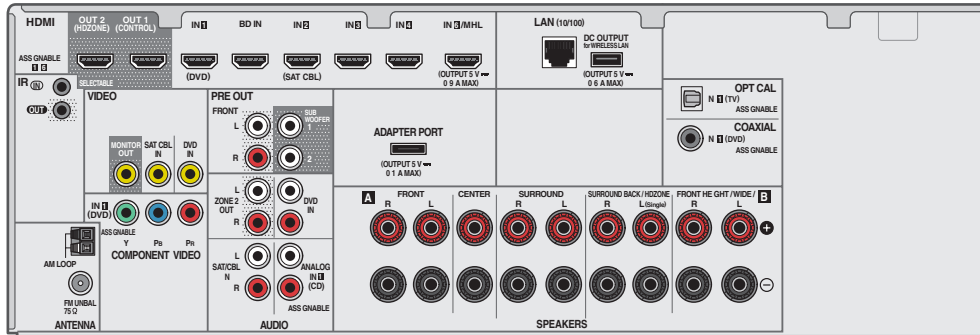

### Note

The input functions below are assigned by default to the receiver's different input terminals. Refer to [The Input Setup menu](#) on [page 40](#) to change the assignments if other connections are used.

Input function	Input Terminals		
	HDMI	Audio	Component
BD	(BD)		
DVD	IN 1	COAX-1	IN 1
SAT/CBL	IN 2		
TV		OPT-1	
HDMI 3	IN 3		
HDMI 4	IN 4		
HDMI 5 (front panel)	IN 5		
HDMI 6/MHL	IN 6		
CD		ANALOG-1	



## Determining the speakers' application

This unit permits you to build various surround systems, in accordance with the number of speakers you have.

- Be sure to connect speakers to the front left and right channels (**L** and **R**).
- It is also possible to only connect one of the surround back speakers (**SB**) or neither.
- If you have two subwoofers, the second subwoofer can be connected to the **SUBWOOFER 2** terminal.

Connecting two subwoofers increases the bass sound to achieve more powerful sound reproduction. In this case, the same sound is output from the two subwoofers.

Choose one from Plans [A] to [E] below.



### Important

- The **Speaker System** setting must be made if you use any of the connections shown below other than [A] (see [Speaker system setting](#) on [page 89](#)).
- The speakers from which sound is output can be switched according to the speaker layout/usage pattern (sound is not necessarily output from all connected speakers). Use the **OUT P.** button to switch the speakers from which sound is output. For details, see [Switching the speaker terminals](#) on [page 71](#).

## [A] 7.2 channel surround system (Front height)

\*Default setting

- **Speaker System** setting: **Normal(SB/FH)**

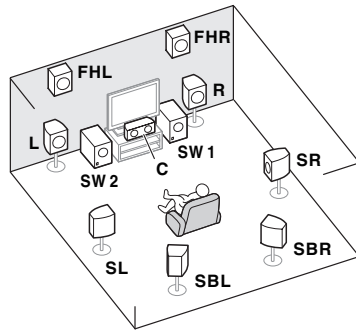

A 7.2 ch surround system connects the left and right front speakers (**L/R**), the center speaker (**C**), the left and right front height speakers (**FHL/FHR**), the left and right surround speakers (**SL/SR**), the left and right surround back speakers (**SBL/SBR**), and the subwoofers (**SW 1/SW 2**).

It is not possible to produce sound simultaneously from the front height speakers and the surround back speakers.

This surround system produces a more true-to-life sound from above.

## [B] 7.2 channel surround system (Front wide)

- **Speaker System** setting: **Normal(SB/FW)**

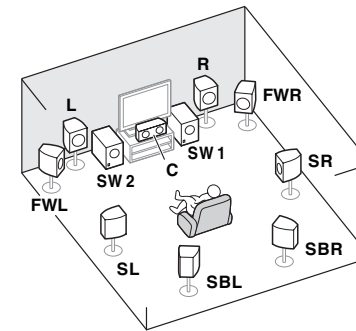

This plan replaces the left and right front height speakers shown in [A] with the left and right front wide speakers (**FWL/FWR**).

It is not possible to produce sound simultaneously from the front wide speakers and the surround back speakers. This surround system provides a sound field with good association between the sounds of the different channels.

## [C] 7.2 channel surround system & Speaker B connection

- **Speaker System** setting: **Speaker B**

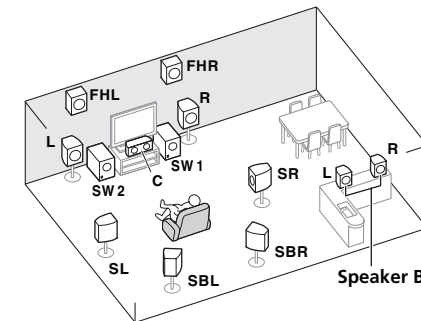

With these connections you can simultaneously enjoy 5.2-channel surround sound in the main zone with stereo playback of the same sound on the B speakers. The same connections also allow for 7.2-channel surround sound in the main zone when not using the B speakers.



### [D] 5.2 channel surround system & Front Bi-amping connection (High quality surround)

- **Speaker System** setting: **Front Bi-Amp**

Bi-amping connection of the front speakers for high sound quality with 5.2-channel surround sound.

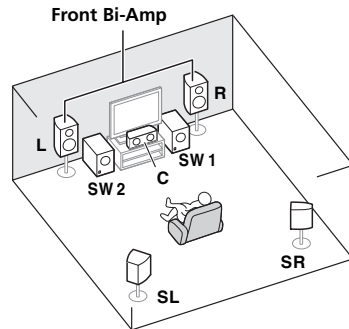

### [E] 5.2 channel surround system & ZONE 2 connection (Multi Zone)

- **Speaker System** setting: **ZONE 2**

With these connections you can simultaneously enjoy 5.2-channel surround sound in the main zone with stereo playback on another component in ZONE 2. (The selection of input devices is limited.)

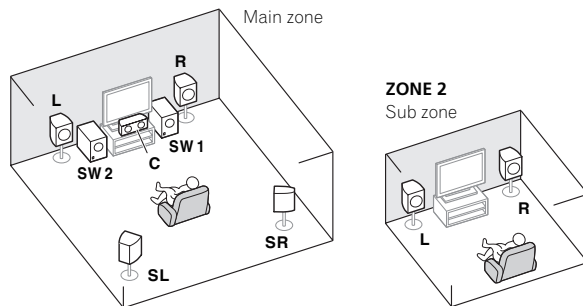

### [F] 5.2 channel surround system & HDZONE connection (Multi Zone)

- **Speaker System** setting: **HDZONE**

With these connections you can simultaneously enjoy 5.2-channel surround sound in the main zone with stereo playback on another component in HDZONE. (The selection of input devices is limited.)

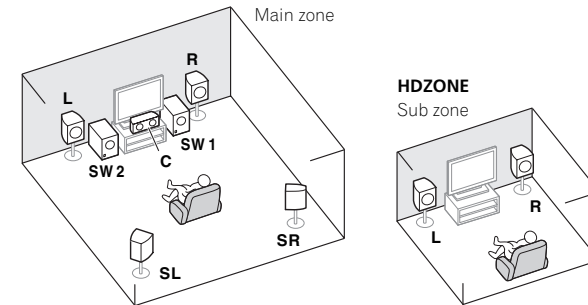

### Other speaker connections

- Your favorite speaker connections can be selected even if you have fewer than 5.2 speakers (except front left/right speakers).
- When not connecting a subwoofer, connect speakers with low frequency reproduction capabilities to the front channel. (The subwoofer's low frequency component is played from the front speakers, so the speakers could be damaged.)
- After connecting, be sure to conduct the **Full Auto MCACC** (speaker environment setting) procedure. See [Automatically conducting optimum sound tuning \(Full Auto MCACC\)](#) on [page 38](#).



## Placing the speakers

Refer to the chart below for placement of the speakers you intend to connect.

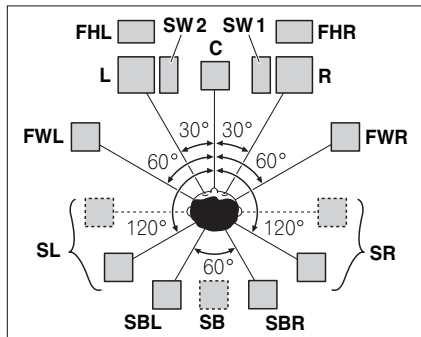

- Place the surround speakers at 120° from the center. If you, (1) use the surround back speaker, and, (2) don't use the front height speakers / front wide speakers, we recommend placing the surround speaker right beside you.
- If you intend to connect only one surround back speaker, place it directly behind you.
- Place the left and right front height speakers at least one meter (3.3 ft.) directly above the left and right front speakers.

## Some tips for improving sound quality

Where you put your speakers in the room has a big effect on the quality of the sound. The following guidelines should help you to get the best sound from your system.

- The subwoofer can be placed on the floor. Ideally, the other speakers should be at about ear-level when you're listening to them. Putting the speakers on the floor (except the subwoofer), or mounting them very high on a wall is not recommended.
- For the best stereo effect, place the front speakers 2 m to 3 m (6 ft. to 9 ft.) apart, at equal distance from the TV.
- If you're going to place speakers around your CRT TV, use shielded speakers or place the speakers at a sufficient distance from your CRT TV.
- If you're using a center speaker, place the front speakers at a wider angle. If not, place them at a narrower angle.
- Place the center speaker above or below the TV so that the sound of the center channel is localized at the TV screen. Also, make sure the center speaker does not cross the line formed by the leading edge of the front left and right speakers.
- It is best to angle the speakers towards the listening position. The angle depends on the size of the room. Use less of an angle for bigger rooms.
- Surround and surround back speakers should be positioned 60 cm to 90 cm (2 ft. to 3 ft.) higher than your ears and tilted slightly downward. Make sure the speakers don't face each other. For DVD-Audio, the speakers should be more directly behind the listener than for home theater playback.
- Try not to place the surround speakers farther away from the listening position than the front and center speakers. Doing so can weaken the surround sound effect.

## Connecting the speakers

Each speaker connection on the receiver comprises a positive (+) and negative (-) terminal. Make sure to match these up with the terminals on the speakers themselves.

This unit supports speakers with a nominal impedance of 6 Ω to 16 Ω.

### CAUTION

- These speaker terminals carry **HAZARDOUS LIVE** voltage. To prevent the risk of electric shock when connecting or disconnecting the speaker cables, disconnect the power cord before touching any uninsulated parts.
- Make sure that all the bare speaker wire is twisted together and inserted fully into the speaker terminal. If any of the bare speaker wire touches the back panel it may cause the power to cut off as a safety measure.

## Bare wire connections

### CAUTION

Make sure that all speakers are securely installed. This not only improves sound quality, but also reduces the risk of damage or injury resulting from speakers being knocked over or falling in the event of external shocks such as earthquakes.

- 1 Twist exposed wire strands together.
- 2 Loosen terminal and insert exposed wire.
- 3 Tighten terminal.

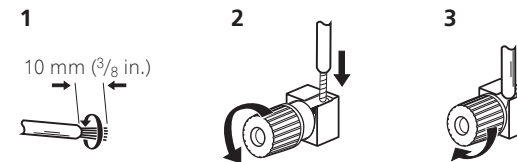

### Notes

- Please refer to the manual that came with your speakers for details on how to connect the other end of the speaker cables to your speakers.
- Use an RCA cable to connect the subwoofer. It is not possible to connect using speaker cables.
- If you have two subwoofers, the second subwoofer can be connected to the **SUBWOOFER 2** terminal. Connecting two subwoofers increases the bass sound to achieve more powerful sound reproduction. In this case, the same sound is output from the two subwoofers.

## Banana plug connections

If you want to use speaker cables terminated with banana plugs, screw the speaker terminal fully shut, then plug the banana plug into the end of the speaker terminal.

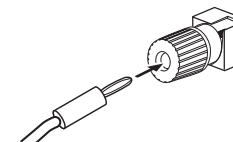

### Installing your speaker system

At the very least, front left and right speakers only are necessary. Note that your main surround speakers should always be connected as a pair, but you can connect just one surround back speaker if you like (it must be connected to the left surround back terminal).

#### Standard surround connection

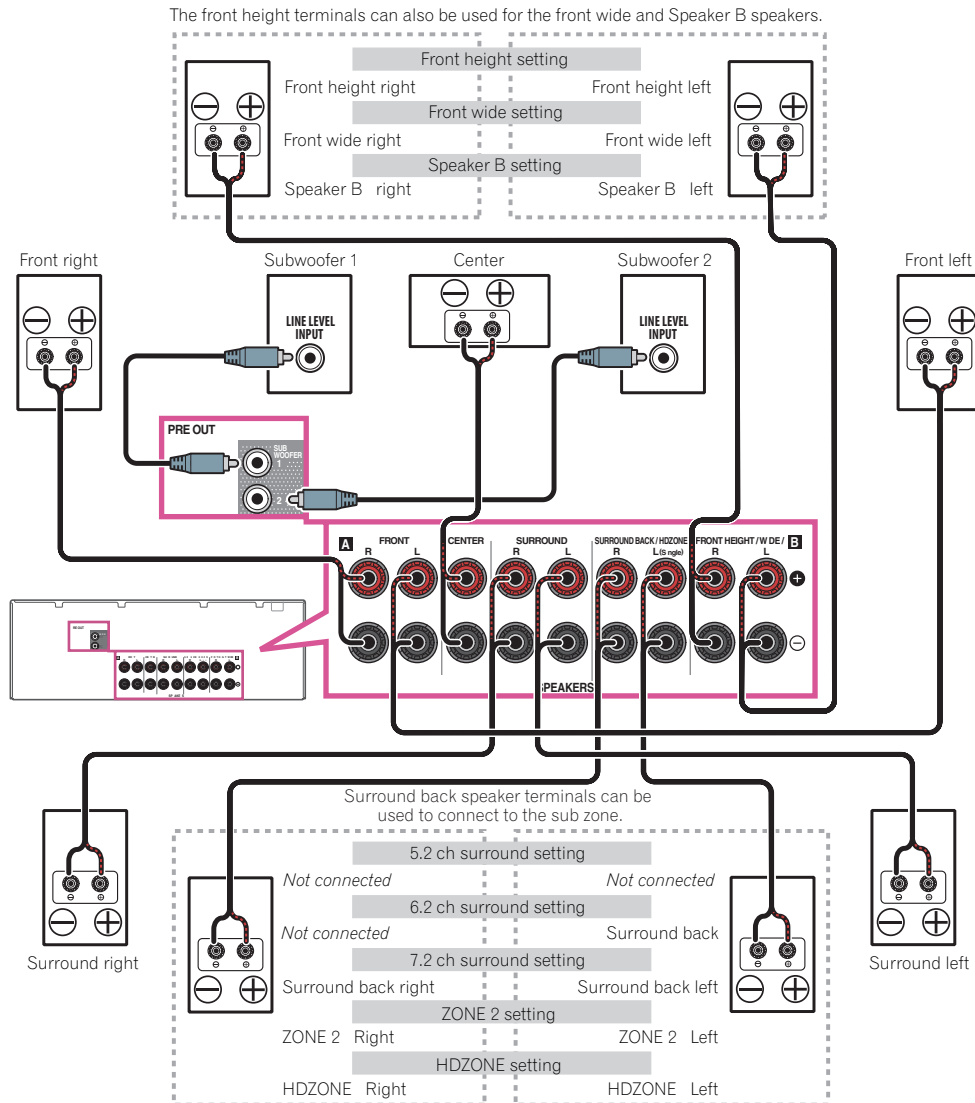

### Bi-amping your speakers

Bi-amping is when you connect the high frequency driver and low frequency driver of your speakers to different amplifiers for better crossover performance. Your speakers must be bi-ampable to do this (having separate terminals for high and low) and the sound improvement will depend on the kind of speakers you're using.

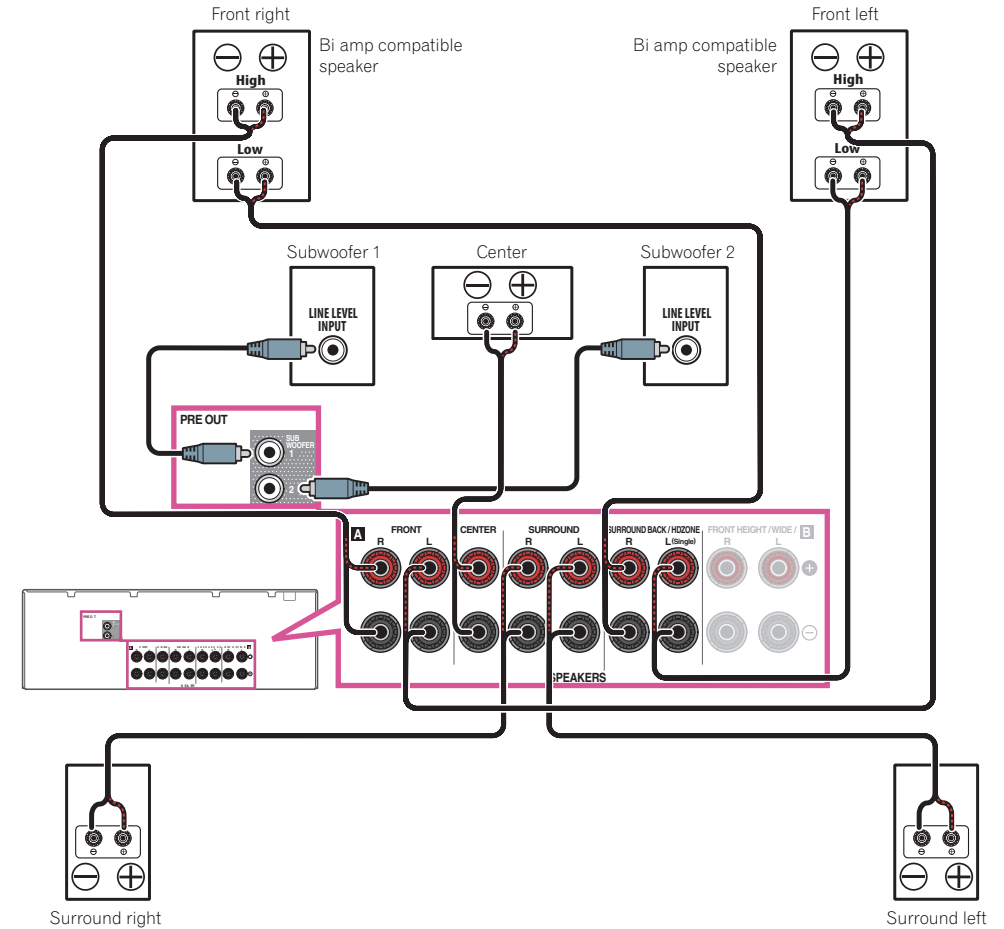

**CAUTION**

- Most speakers with both **High** and **Low** terminals have two metal plates that connect the **High** to the **Low** terminals. These must be removed when you are bi-amping the speakers or you could severely damage the amplifier. See your speaker manual for more information.
- If your speakers have a removable crossover network, make sure you do not remove it for bi-amping. Doing so may damage your speakers.



## Bi-wiring your speakers

Your speakers can also be bi-wired if they support bi-amping.

- With these connections, the **Speaker System** setting makes no difference.



### CAUTION

- Don't connect different speakers from the same terminal in this way.
  - When bi-wiring as well, heed the cautions for bi-amping shown above.
- **To bi-wire a speaker, connect two speaker cords to the speaker terminal on the receiver.**  
Using a banana plug for the second connection is recommended.

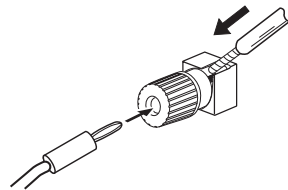

## Selecting the Speaker system

The front height terminals can be used for front wide and Speaker B connections, in addition to for the front height speakers. Also, the surround back terminals can be used for bi-amping and ZONE 2 connections, in addition to for the surround back speakers. Make this setting according to the application.

### Front height setup

*\*Default setting*

- 1 Connect a pair of speakers to the front height speaker terminals.**  
See [Standard surround connection](#) on [page 22](#).
- 2 If necessary, select 'Normal(SB/FH)' from the Speaker System menu.**  
See [Speaker system setting](#) on [page 89](#) to do this.

### Front wide setup

- 1 Connect a pair of speakers to the front height speaker terminals.**  
See [Standard surround connection](#) on [page 22](#).
- 2 Select 'Normal(SB/FW)' from the Speaker System menu.**  
See [Speaker system setting](#) on [page 89](#) to do this.

### Speaker B setup

You can listen to stereo playback in another room.

- 1 Connect a pair of speakers to the front height speaker terminals.**  
See [Standard surround connection](#) on [page 22](#).
- 2 Select 'Speaker B' from the Speaker System menu.**  
See [Speaker system setting](#) on [page 89](#) to do this.

## Bi-Amping setup

Bi-amping connection of the front speakers for high sound quality with 5.1-channel surround sound.

- 1 Connect bi-amp compatible speakers to the front and surround back speaker terminals.**  
See [Bi-amping your speakers](#) on [page 22](#).
- 2 Select 'Front Bi-Amp' from the Speaker System menu.**  
See [Speaker system setting](#) on [page 89](#) to do this.

## ZONE 2 setup

With these connections you can simultaneously enjoy 5.1-channel surround sound in the main zone with stereo playback on another component in ZONE 2.

- 1 Connect a pair of speakers to the surround back speaker terminals.**  
See [Standard surround connection](#) on [page 22](#).
- 2 Select 'ZONE 2' from the Speaker System menu.**  
See [Speaker system setting](#) on [page 89](#) to do this.

## HDZONE setup

With these connections you can simultaneously enjoy 5.1-channel surround sound in the main zone with stereo playback on another component in HDZONE.

- 1 Connect a pair of speakers to the surround back speaker terminals.**  
See [Standard surround connection](#) on [page 22](#).
- 2 Select 'HDZONE' from the Speaker System menu.**  
See [Speaker system setting](#) on [page 89](#) to do this.

## About the audio connection

	Types of cables and terminals	Transferable audio signals
↑ Sound signal priority	HDMI 	HD audio
	Digital (Coaxial)  Digital (Optical) 	Conventional digital audio
	RCA (Analog) (White/Red) 	Conventional analog audio

- With an HDMI cable, video and audio signals can be transferred in high quality over a single cable.
- For HD audio, see [About HDMI](#) on [page 24](#).



## About the video converter

The video converter ensures that all video sources are output through the **HDMI OUT** terminal. If the TV is only connected to the receiver's composite **VIDEO MONITOR OUT** jacks, all the other video devices must be connected through composite connections. If several video components are assigned to the same input function (see [The Input Setup menu](#) on [page 40](#)), the converter gives priority to HDMI, component, then composite (in that order).

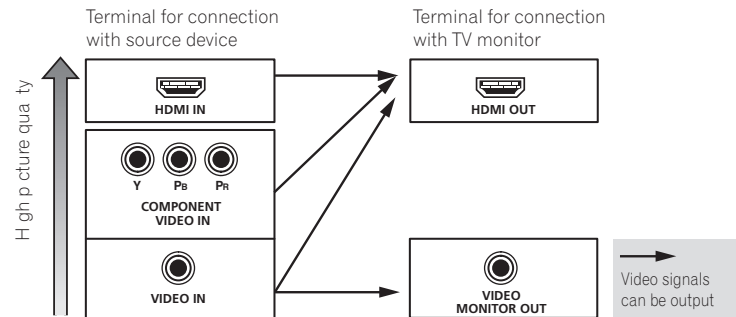

### Notes

- With factory default settings, video from the video cable or component cable will not be output from the HDMI terminal. To output video, you must switch video input to the device connected with the video cable or component cable and set **V.CONV** to **ON** ([page 69](#)).
- The only exception is HDMI: since this resolution cannot be downsampled, you must connect your monitor/TV to the receiver's HDMI output when connecting this video source.
- If the video signal does not appear on your TV, try adjusting the resolution settings on your component or display. Note that some components (such as video game units) have resolutions that may not be converted. In this case, try switching Digital Video Conversion (in [Setting the Video options](#) on [page 69](#)) **OFF**.
- The signal input resolutions that can be converted from the component video input for the HDMI output are 480i/576i, 480p/576p, 720p and 1080i. 1080p signals cannot be converted.

*This item incorporates copy protection technology that is protected by U.S. patents and other intellectual property rights of Rovi Corporation. Reverse engineering and disassembly are prohibited.*

## About HDMI

The HDMI connection transfers uncompressed digital video, as well as almost every kind of digital audio. This receiver incorporates High-Definition Multimedia Interface (HDMI<sup>®/™</sup>) technology. This receiver supports the functions described below through HDMI connections.

- Digital transfer of uncompressed video (contents protected by HDCP (1080p/24, 1080p/60, etc.))
- 3D signal transfer
- Deep Color signal transfer
- x.v.Color signal transfer
- ARC (Audio Return Channel)
- 4K signal transfer
  - This may not operate properly, depending on the connected equipment.
  - 4K 24p, 4K 25p, 4K 30p, 4K 50p and 4K 60p signals are supported.
- Input of multi-channel linear PCM digital audio signals (192 kHz or less) for up to 8 channels
- Input of the following digital audio formats:
  - Dolby Digital, Dolby Digital Plus, DTS, High bitrate audio (Dolby TrueHD, DTS-HD Master Audio, DTS-HD High Resolution Audio), CD, SACD (DSD signal)
- Synchronized operation with components using the **Control** with HDMI function (see [Control with HDMI function](#) on [page 62](#))



### Notes

- An HDMI connection can only be made with DVI-equipped components compatible with both DVI and High Bandwidth Digital Content Protection (HDCP). If you choose to connect to a DVI connector, you will need a separate adaptor (DVI→HDMI) to do so. A DVI connection, however, does not support audio signals. Consult your local audio dealer for more information.
- If you connect a component that is not compatible with HDCP, an **HDCP ERROR** message is displayed on the front panel display. Some components that are compatible with HDCP still cause this message to be displayed, but so long as there is no problem with displaying video this is not a malfunction.
- Depending on the component you have connected, using a DVI connection may result in unreliable signal transfers.
- This receiver supports SACD, Dolby Digital Plus, Dolby TrueHD and DTS-HD Master Audio. To take advantage of these formats, however, make sure that the component connected to this receiver also supports the corresponding format.
- Use a High Speed HDMI<sup>®/™</sup> Cable. If an HDMI cable other than a High Speed HDMI<sup>®/™</sup> Cable is used, it may not work properly.
- When an HDMI cable with a built-in equalizer is connected, it may not operate properly.
- Signal transfer is only possible when connected to a compatible component.
- HDMI format digital audio transmissions require a longer time to be recognized. Due to this, interruption in the audio may occur when switching between audio formats or beginning playback.
- Turning on/off the device connected to this unit's **HDMI OUT** terminal during playback, or disconnecting/connecting the HDMI cable during playback, may cause noise or interrupted audio.

*The terms HDMI and HDMI High-Definition Multimedia Interface, and the HDMI Logo are trademarks or registered trademarks of HDMI Licensing, LLC in the United States and other countries.*

*"x.v.Color" and x.v.Color are trademarks of Sony Corporation.*





## Connecting your TV and playback components

### Connecting using HDMI

If you have an HDMI or DVI (with HDCP) equipped component (Blu-ray Disc player (BD), etc.), you can connect it to this receiver using a commercially available HDMI cable.

If the TV and playback components support the **Control with HDMI** feature, the convenient **Control with HDMI** functions can be used (see [Control with HDMI function](#) on [page 62](#)).

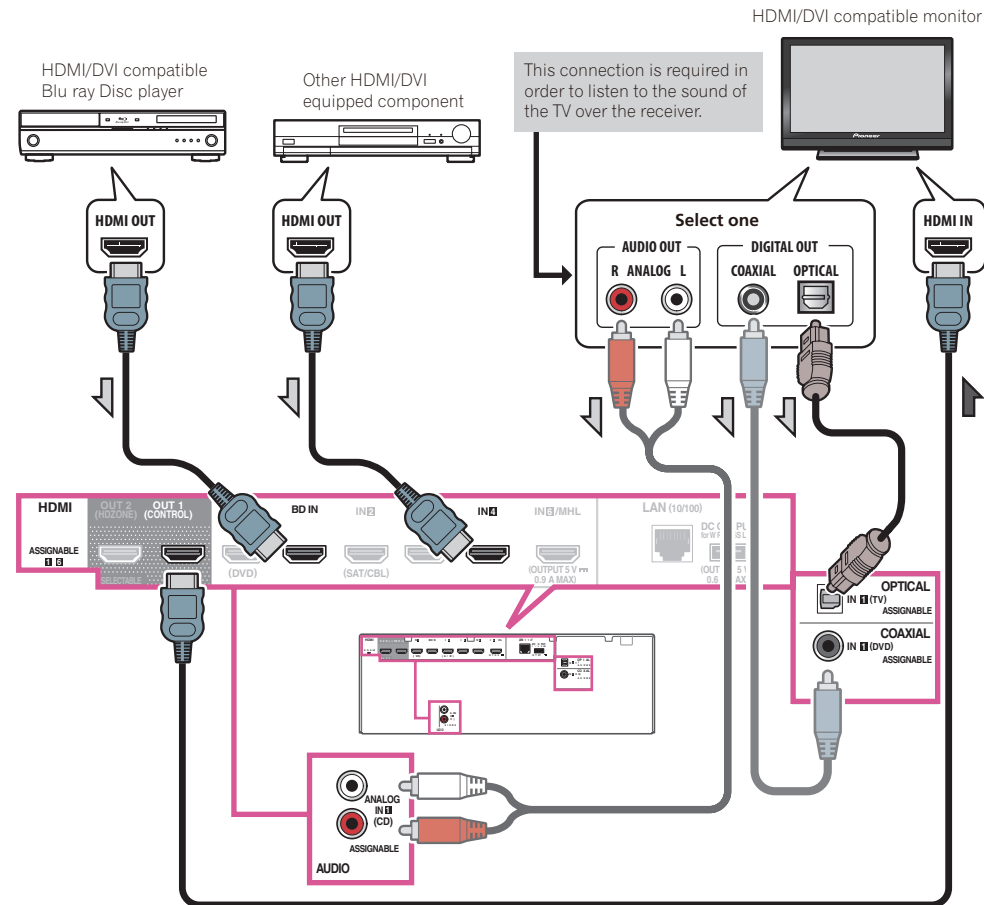

- When connecting to an HDMI/DVI-compatible monitor using the **HDMI OUT 2** terminal, switch the HDMI output setting to **OUT 2** or **OUT 1+2**. See [Switching the HDMI output](#) on [page 71](#). Also, **MAIN/HDZONE** must be set to **MAIN** beforehand ([page 94](#)).
- For input components, connections other than HDMI connections are also possible (see [Connecting your DVD player with no HDMI output](#) on [page 26](#)).
- If you want to listen to the sound of the TV over the receiver, connect the receiver and TV with audio cables.
  - When the TV and receiver are connected by HDMI connections, if the TV supports the HDMI ARC (Audio Return Channel) function, the sound of the TV can be input to the receiver via the **HDMI OUT** terminal, so there is no need to connect an audio cable. In this case, set **ARC** at **HDMI Setup** to **ON** (see [HDMI Setup](#) on [page 63](#)).
  - After setting the **ARC**, some time may be required for the connected device to be recognized and the sound to be produced.
  - If you use a coaxial digital audio cable or RCA (analog) audio cable, you'll need to tell the receiver which digital or analog audio input you connected the TV to (see [The Input Setup menu](#) on [page 40](#)).
  - Please refer to the TV's operation manual for directions on connections and setup for the TV.



### Connecting your DVD player with no HDMI output

This diagram shows connections of a TV (with HDMI input) and DVD player (or other playback component with no HDMI output) to the receiver.

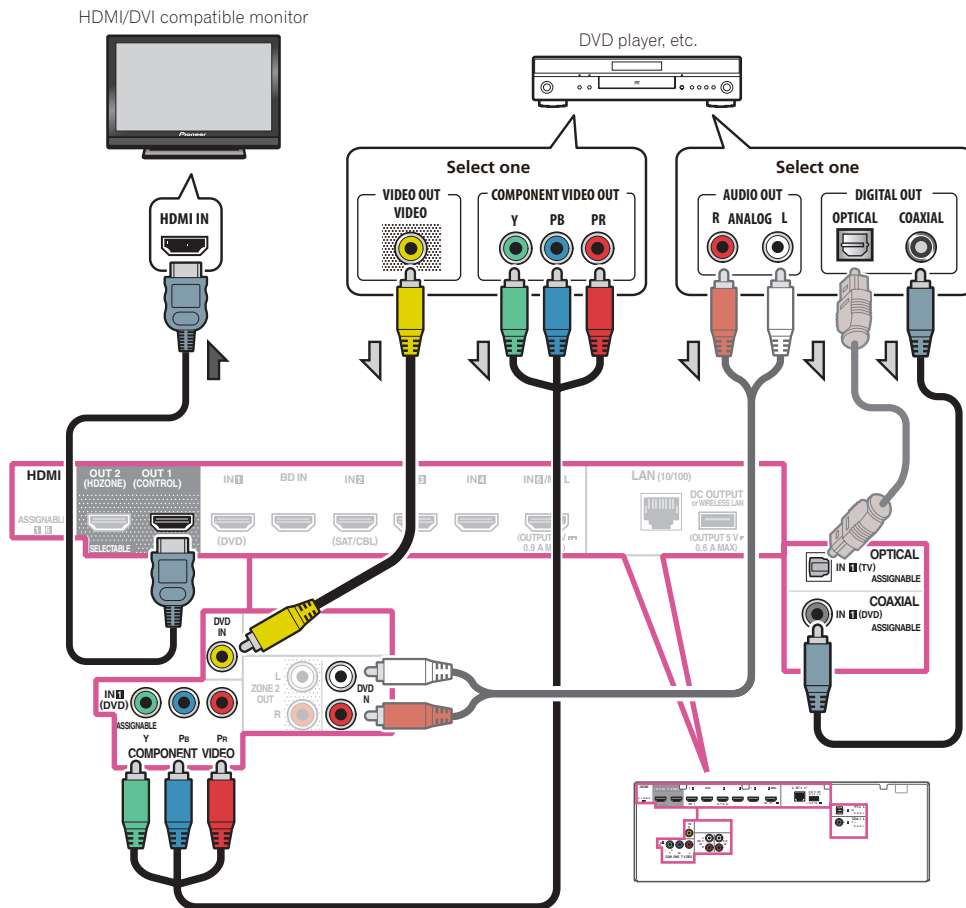

- With factory default settings, video from the video cable or component cable will not be output from the HDMI terminal. To output video, you must switch video input to the device connected with the video cable or component cable and set **V.CONV** to **ON** (page 69).
- If you want to listen to the sound of the TV over the receiver, connect the receiver and TV with audio cables (page 25).
- When the TV and receiver are connected by HDMI connections, if the TV supports the HDMI ARC (Audio Return Channel) function, the sound of the TV can be input to the receiver via the **HDMI OUT 1** terminal, so there is no need to connect an audio cable. In this case, set **ARC** at **HDMI Setup** to **ON** (see **HDMI Setup** on page 63).
- If you use an optical digital audio cable or RCA (analog) audio cable, you'll need to tell the receiver which digital input you connected the player to (see **The Input Setup menu** on page 40).
- When the network function or **iPod/USB** input is selected with HDZONE, video connected with the video cable or component cable is not output from the HDMI terminal. To output video, turn off HDZONE or set HDZONE to some other input (page 72).



## Connecting your TV with no HDMI input

This diagram shows connections of a TV (with no HDMI input) and DVD player (or other playback component) to the receiver.



### Important

- With these connections, the picture is not output to the TV even if the DVD player is connected with an HDMI cable. Connect the receiver and TV using the same type of video cable as used to connect the receiver and player.
- Also, when the receiver and TV are connected by anything other than an HDMI cable, the OSD function allowing display of the receiver's settings, operations, etc., on the TV's screen cannot be used. In this case, watch the receiver's front panel display while performing the various operations and making settings.

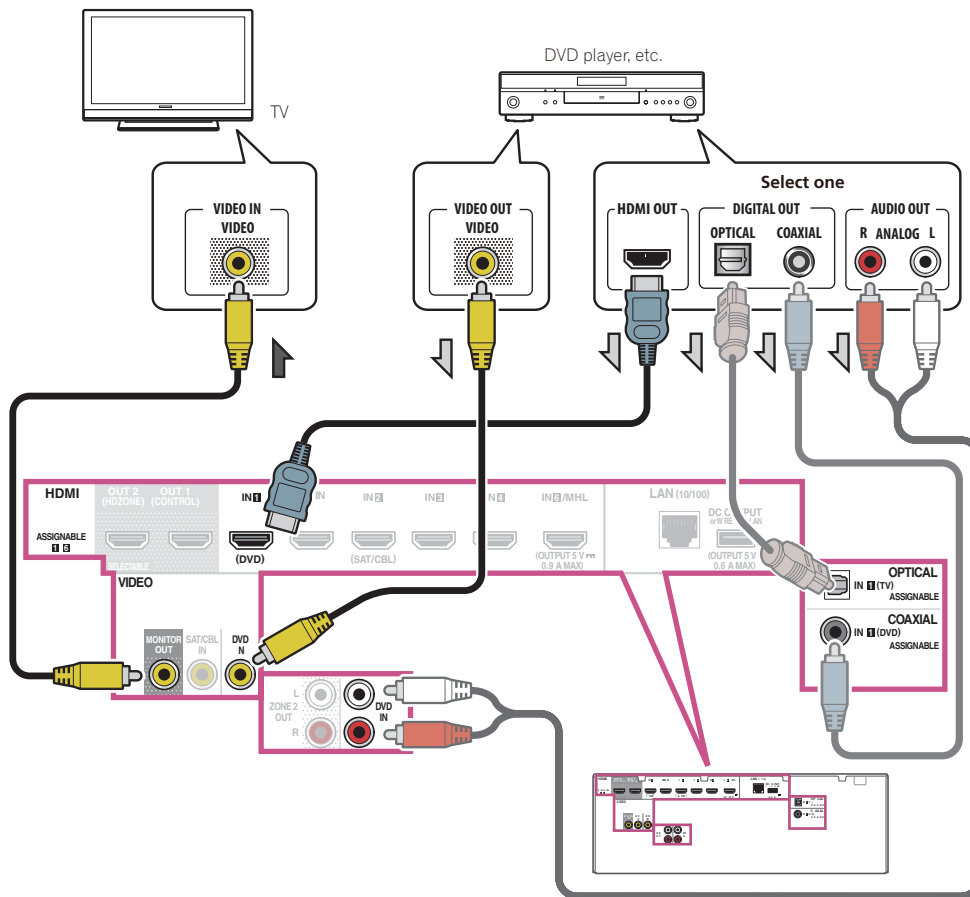

- In order to listening to HD audio with this receiver, connect an HDMI cable, and use analog video cable for video signal input. Depending on the player, it may not be possible to output video signals to both HDMI and other video output (composite, etc.) simultaneously, and it may be necessary to make video output settings. Please refer to the operating instructions supplied with your player for more information.
- If you want to listen to the sound of the TV over the receiver, connect the receiver and TV with audio cables ([page 25](#)).
- If you use an optical digital audio cable or RCA (analog) audio cable, you'll need to tell the receiver which digital input you connected the player to (see [The Input Setup menu](#) on [page 40](#)).

## Connecting a satellite/cable receiver or other set-top box

Satellite and cable receivers, and terrestrial digital TV tuners are all examples of so-called 'set-top boxes'. When you set up the receiver you'll need to tell the receiver which input you connected the set-top box to (see [The Input Setup menu](#) on [page 40](#)).

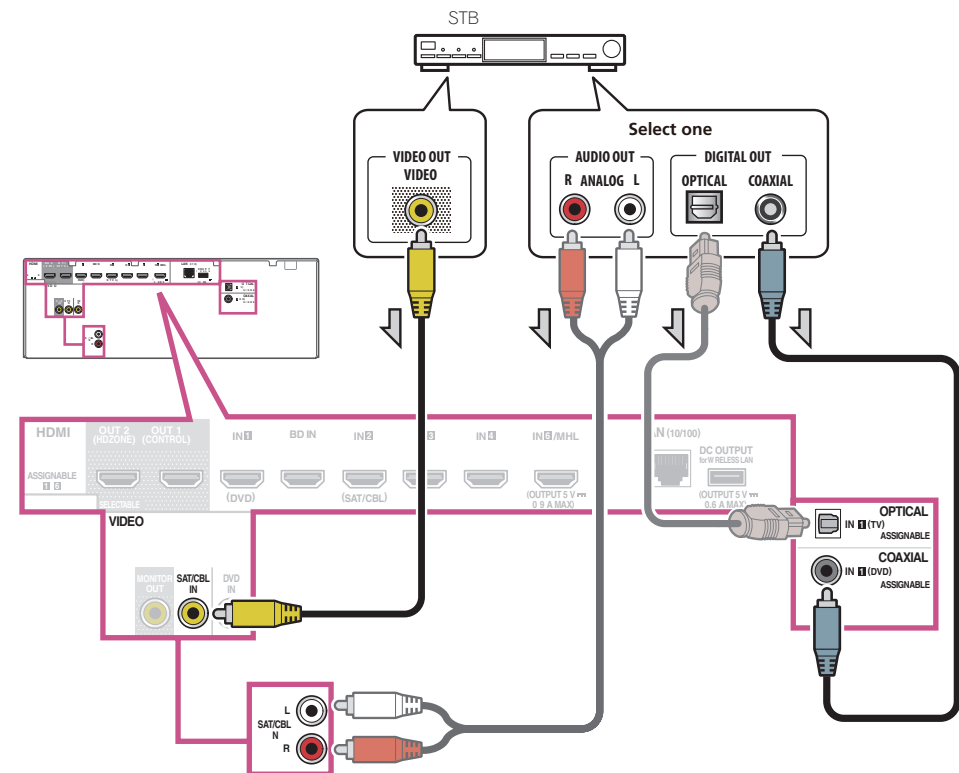

- With factory default settings, video from the video cable or component cable will not be output from the HDMI terminal. To output video, you must switch video input to the device connected with the video cable or component cable and set **V.CONV** to **ON** ([page 69](#)).

- When the network function or **iPod/USB** input is selected with HDZONE, video connected with the video cable or component cable is not output from the HDMI terminal. To output video, turn off HDZONE or set HDZONE to some other input ([page 72](#)).
- If your set-top box is equipped with an HDMI output terminal, we recommend connecting it to the receiver's **HDMI SAT/CBL IN** terminal. When doing so, also connect the receiver and TV by HDMI (see [Connecting using HDMI](#) on [page 25](#)).

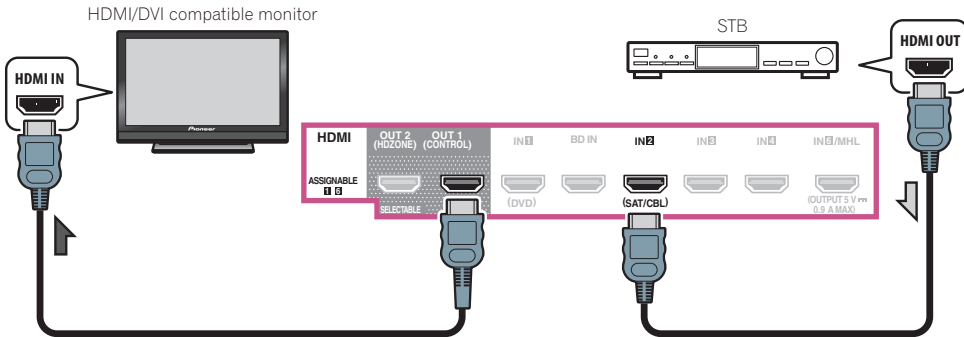

- Even if your set-top box is equipped with an HDMI output terminal, in some cases the sound is output from the digital audio output (optical or coaxial) and only the video is output from the HDMI output terminal. In this case, make the HDMI and digital audio connections as shown below.

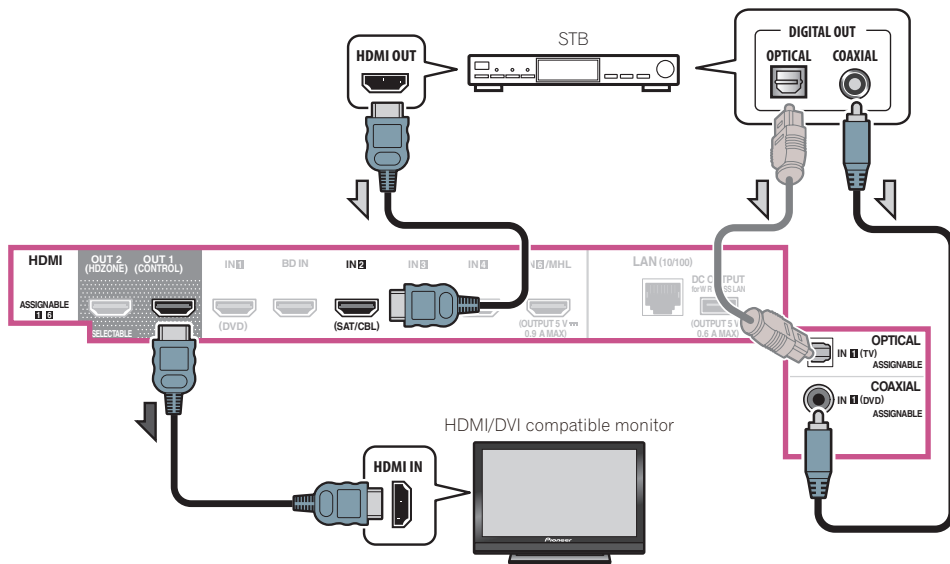

### Connecting other audio components

This receiver has both digital and analog inputs, allowing you to connect audio components for playback. When you set up the receiver you'll need to tell the receiver which input you connected the component to (see also [The Input Setup menu](#) on [page 40](#)).

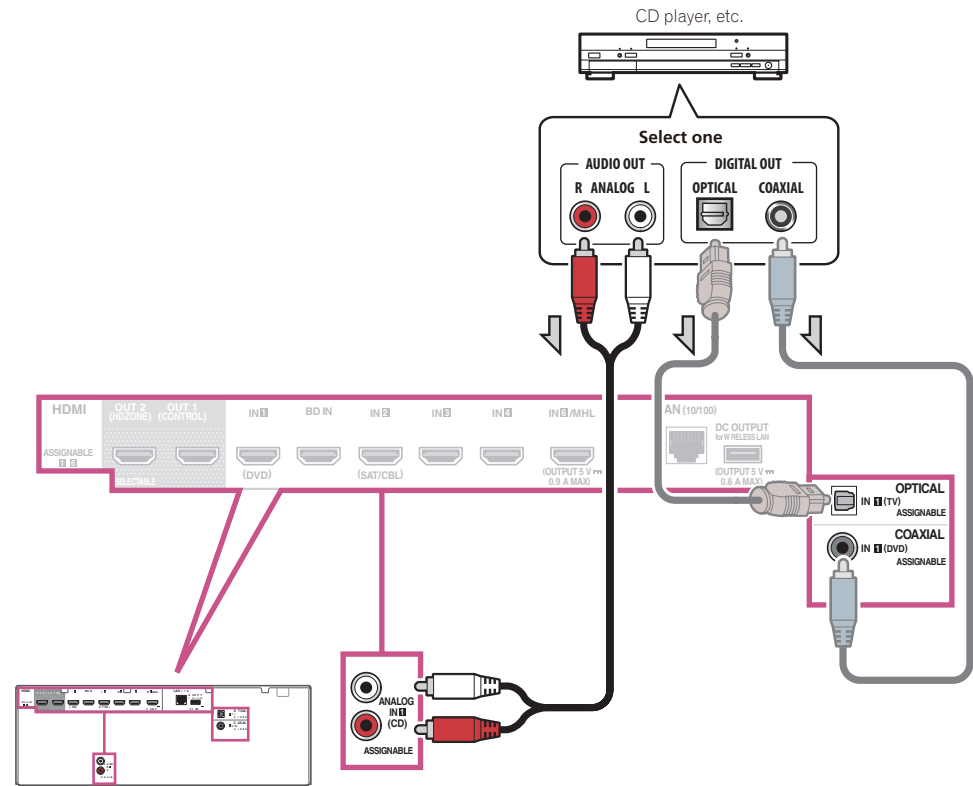

- If your turntable has line-level outputs (i.e., it has a built-in phono pre-amp), connect it to the **ANALOG IN 1 (CD)** inputs instead.

— If you use a digital audio cable or RCA (analog) audio cable, you'll need to tell the receiver which digital input you connected the set-top box to (see [The Input Setup menu](#) on [page 40](#)).



## Connecting additional amplifiers

This receiver has more than enough power for any home use, but it's possible to add additional amplifiers to front and subwoofer channels of your system using the pre-outs. Make the connections shown below to add amplifiers to power your speakers.

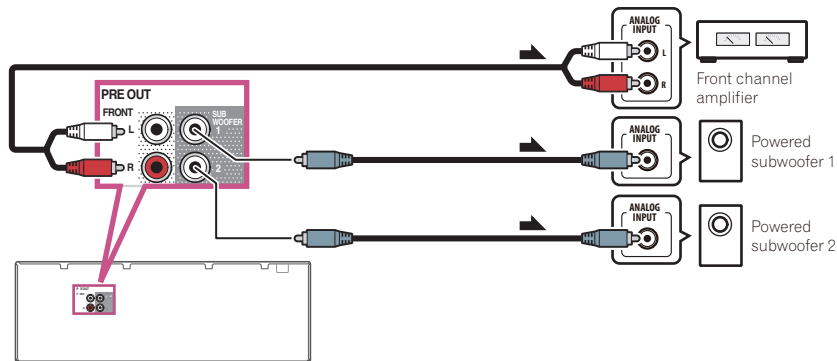

- If you're not using a subwoofer, change the front speaker setting (see [Speaker Setting](#) on [page 86](#)) to **LARGE**.
- If you have two subwoofers, the second subwoofer can be connected to the **SUBWOOFER 2** terminal. Connecting two subwoofers increases the bass sound to achieve more powerful sound reproduction. In this case, the same sound is output from the two subwoofers.
- To hear sound only from the pre-outs, switch the speaker terminals to **SP: OFF** ([page 71](#)) or simply disconnect any speakers that are connected directly to the receiver.

## Connecting AM/FM antennas

Connect the AM loop antenna and the FM wire antenna as shown below. To improve reception and sound quality, connect external antennas (see [Connecting external antennas](#) on [page 30](#)).

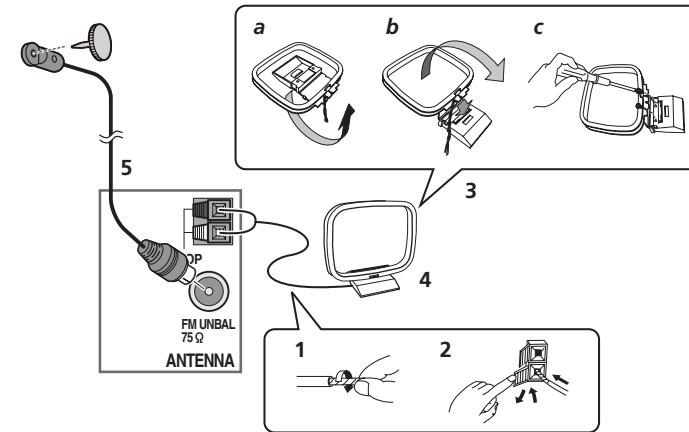

- 1 Pull off the protective shields of both AM antenna wires.**
- 2 Push open the tabs, then insert one wire fully into each terminal, then release the tabs to secure the AM antenna wires.**
- 3 Fix the AM loop antenna to the attached stand.**  
To fix the stand to the antenna, bend in the direction indicated by the arrow (*fig. a*) then clip the loop onto the stand (*fig. b*).
  - If you plan to mount the AM antenna to a wall or other surface, secure the stand with screws (*fig. c*) before clipping the loop to the stand. Make sure the reception is clear.
- 4 Place the AM antenna on a flat surface and in a direction giving the best reception.**
- 5 Connect the FM wire antenna into the FM antenna socket.**

For best results, extend the FM antenna fully and fix to a wall or door frame. Don't drape loosely or leave coiled up.

## Connecting external antennas

To improve FM reception, connect an external FM antenna to **FM UNBAL 75 Ω**.

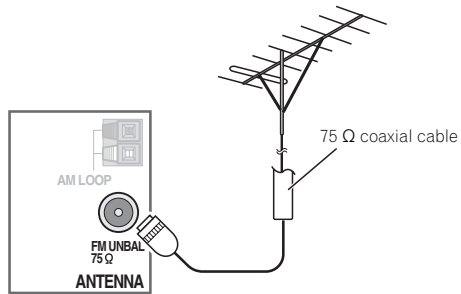

To improve AM reception, connect a 5 m to 6 m (16 ft. to 20 ft.) length of vinyl-coated wire to the **AM LOOP** terminals without disconnecting the supplied AM loop antenna. For the best possible reception, suspend horizontally outdoors.

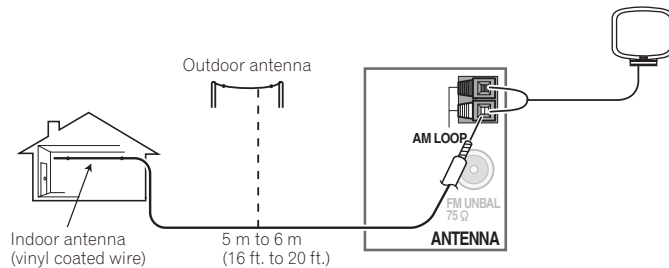

## MULTI-ZONE setup

This receiver can power up to three independent systems in separate rooms after you have made the proper MULTI-ZONE connections.

Different sources can be playing in three zones at the same time or, depending on your needs, the same source can also be used. The main and sub zones have independent power (the main zone power can be off while one (or both) of the sub zones is on) and the sub zones can be controlled by the remote or front panel controls.

## Making MULTI-ZONE connections

It is possible to make these connections if you have a separate TV and speakers for your primary sub zone (**ZONE 2**). You will also need a separate amplifier if you are not using the speaker terminals for your primary sub zone. (For details, see [MULTI-ZONE setup using speaker terminals \(ZONE 2\)](#) on [page 31](#).) Also, if the separate receiver in the sub zone has an HDMI input terminal, this unit's HDMI input can be played as **HDZONE**. Here are two primary sub zone setups possible with this system. Choose whichever works best for you.

### Important

- The settings must be changed at **ZONE Setup** in order to use the multi-zone function ([page 94](#)).
- MAIN/HDZONE** at **ZONE Setup** must be set to **HDZONE** in order to use the **HDZONE** function ([page 94](#)).

## MULTI-ZONE listening options

The following table shows the signals that can be output to **ZONE 2** and **HDZONE**:

Sub Zone	Input functions available
<b>ZONE 2</b> <a>	<b>DVD, SAT/CBL, INTERNET RADIO, PANDORA, MEDIA SERVER, FAVORITES, iPod/USB, TV, CD, TUNER, ADAPTER PORT</b> (Outputs analog audio)
<b>HDZONE</b> (HDMI) <b>	<b>BD, DVD, SAT/CBL, INTERNET RADIO, PANDORA, MEDIA SERVER, FAVORITES, iPod/USB, HDMI 1, HDMI 2, HDMI 3, HDMI 4, HDMI 5, HDMI 6/MHL</b> (Outputs HDMI audio and video signals)

- a
- It is not possible to down-convert the audio input signal from the **HDMI** input terminals or digital input terminals (**OPTICAL** and **COAXIAL**) and output them to **ZONE 2**.
  - When any of the **INTERNET RADIO, PANDORA, MEDIA SERVER, FAVORITES, iPod/USB** or **ADAPTER PORT** inputs is selected in the main zone, it is only possible to select the same input as in the main zone for the **ZONE 2**. (Inputs other than the ones listed here can be selected.)
- The same limitations apply when one of the above inputs is selected for the **ZONE 2**.
- b
- The inputs that can be switched differ according to how terminals **HDMI IN 1** to **IN 6** are assigned. Upon shipment from the factory, the input terminals are assigned to **DVD, SAT/CBL, HDMI 3, HDMI 4, HDMI 5** and **HDMI 6**, in order starting from terminal **HDMI IN 1**.
  - The video/audio signals of the RCA analog input terminals, the digital input terminals (**OPTICAL** and **COAXIAL**) and the **COMPONENT VIDEO** input terminals cannot be up-converted and output to the **HDZONE**.
  - When any of the **HDMI 3** to **HDMI 6/MHL** inputs is selected in the main zone, it is only possible to select the same input as in the main zone for the **HDZONE**. (Inputs other than the ones listed here can be selected.)
- The same limitations apply when one of the above inputs is selected for the **HDZONE**.
- When any of the **INTERNET RADIO, PANDORA, MEDIA SERVER, FAVORITES, or iPod/USB** inputs is selected in the main zone, it is only possible to select the same input as in the main zone for the **HDZONE**. (Inputs other than the ones listed here can be selected.)
- The same limitations apply when one of the above inputs is selected for the **HDZONE**.

### Basic MULTI-ZONE setup (ZONE 2)

- **Connect a separate amplifier to the AUDIO ZONE 2 OUT jacks on this receiver.**  
You should have a pair of speakers attached to the sub zone amplifier as shown in the following illustration.

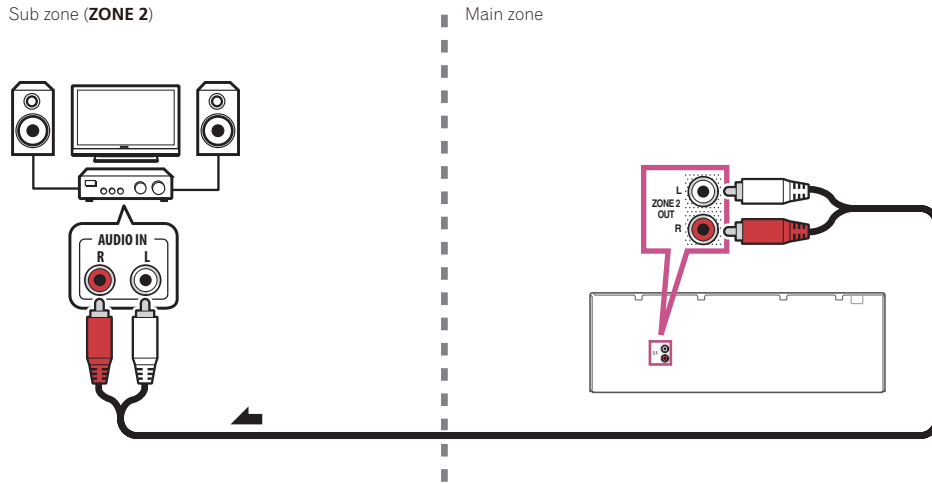

### MULTI-ZONE setup using speaker terminals (ZONE 2)

You must select **ZONE 2** in [Speaker system setting](#) (page 89) to use this setup.

- **Connect a pair of speakers to the surround back speaker terminals.**  
You should have a pair of speakers attached to the surround back speaker terminals as shown below.

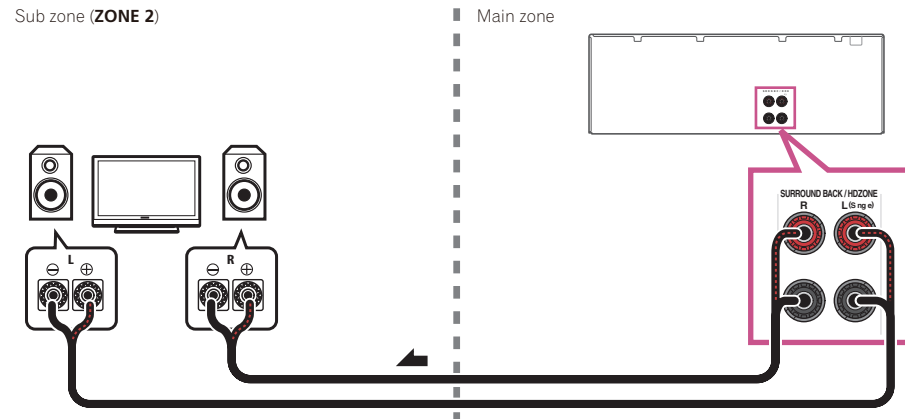

### MULTI-ZONE setup using HDMI terminal (HDZONE)



#### Important

- The settings must be changed at **ZONE Setup** in order to use the **HDZONE** function (page 94).
- To use the **HDZONE** functions, set **Control** or **Control Mode** in **HDMI Setup** to **OFF**. For details, see [HDMI Setup](#) on page 63.

- **Connect a separate receiver to the HDMI OUT 2 (HDZONE) terminal on this receiver.**  
Connect speakers and a TV to the **HDZONE** receiver as shown on the illustration below.

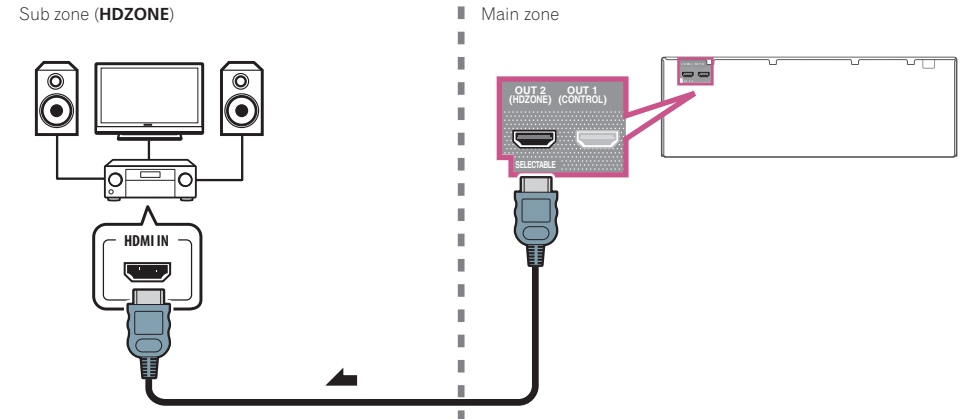

### Multi-zone connection using the HDMI terminal and speaker terminals (HDZONE)



#### Important

- The settings must be changed at **ZONE Setup** in order to use the **HDZONE** function ([page 94](#)).
- To use the **HDZONE** functions, set **Control** or **Control Mode** in **HDMI Setup** to **OFF**. For details, see [HDMI Setup](#) on [page 63](#).
- You must select **HDZONE** in [Speaker system setting](#) ([page 89](#)) to use this setup.

#### 1 Connect a pair of speakers to the surround back speaker terminals.

You should have a pair of speakers attached to the surround back speaker terminals as shown below.

#### 2 Connect a TV monitor to the HDMI OUT 2 (HDZONE) terminal on this receiver.

Sub zone (HDZONE)

Main zone

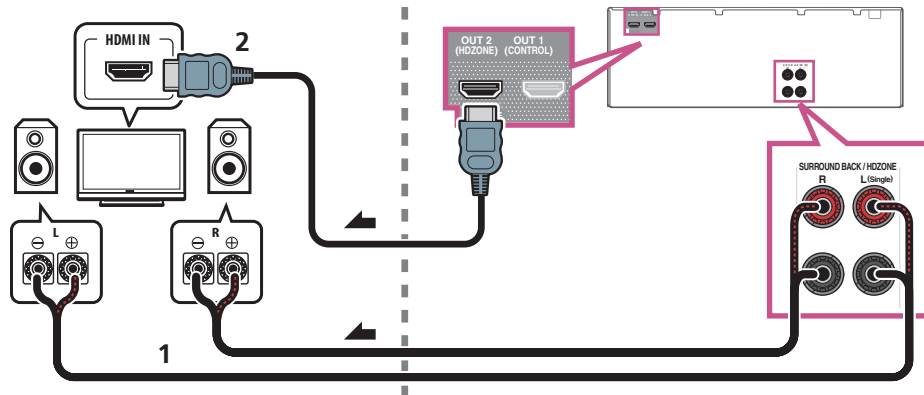

### Connecting to the network through LAN interface

By connecting this receiver to the network via the LAN terminal, you can listen to Internet radio stations. To listen to Internet radio stations, you must sign a contract with an ISP (Internet Service Provider) beforehand.

When connected in this way, you can play audio files stored on the components on the local network, including your computer.

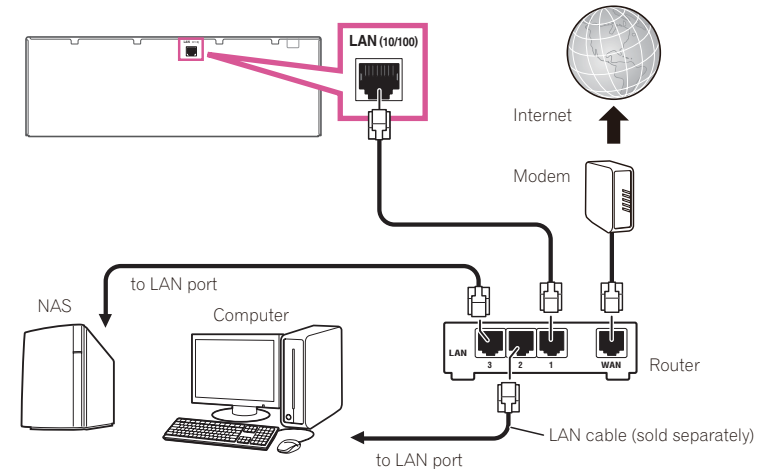

Connect the LAN terminal on this receiver to the LAN terminal on your router (with or without the built-in DHCP server function) with a straight LAN cable (CAT 5 or higher).

Turn on the DHCP server function of your router. In case your router does not have the built-in DHCP server function, it is necessary to set up the network manually. For details, see [Network Setup menu](#) on [page 91](#).

#### LAN terminal specifications

- LAN terminal : Ethernet jack (10BASE-T/100BASE-TX)



#### Notes

- Refer to the operation manual of the equipment you have as the connected equipment and connection method may differ depending on your Internet environment.
- When using a broadband Internet connection, a contract with an Internet service provider is required. For more details, contact your nearest Internet service provider.



## Connecting optional *Bluetooth* ADAPTER

When the *Bluetooth*® ADAPTER (AS-BT100 or AS-BT200) is connected to this receiver, a product equipped with *Bluetooth* wireless technology (portable cell phone, digital music player, etc.) can be used to listen to music wirelessly.

- The *Bluetooth* wireless technology enabled device must support A2DP profiles.
- Pioneer does not guarantee proper connection and operation of this unit with all *Bluetooth* wireless technology enabled devices.

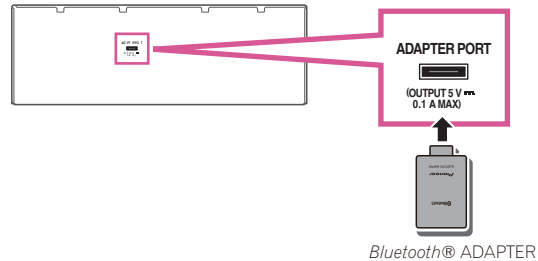

### Important

- Do not move the receiver with the *Bluetooth* ADAPTER connected. Doing so could cause damage or faulty contact.
- **Switch the receiver into standby and connect *Bluetooth* ADAPTER to the ADAPTER PORT.**
- For instructions on playing the *Bluetooth* wireless technology device, see [Pairing the Bluetooth ADAPTER and Bluetooth wireless technology device](#) on [page 49](#).

## Connecting an iPod

This receiver has a dedicated iPod terminal that will allow you to control playback of audio content from your iPod using the controls of this receiver.

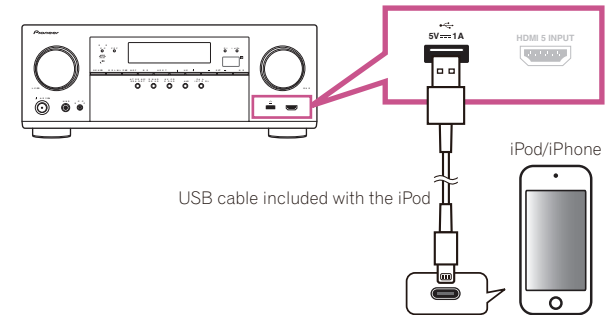

### Tip

- An iPod/iPhone can be connected to the receiver. For details on supported models and versions of the respective products, see [Playing an iPod](#) on [page 45](#).
- **Switch the receiver into standby, and then use the iPod cable to connect your iPod to the iPod/iPhone terminal on the front panel of this receiver.**
- For the cable connection, also refer to the operating instructions for your iPod.
- When connecting an iPhone to this unit, keep the iPhone at least 20 cm (0.66 ft) away from this unit. If the iPhone is kept closer to this unit and a telephone call is received by the iPhone, noise may be output from this device.
- iPod recharging occurs whenever an iPod is connected to this unit. (Recharging is enabled only when the unit's power is turned on.)
- For instructions on playing the iPod, see [Playing an iPod](#) on [page 45](#).

## Connecting a USB device

It is possible to play audio and photo files by connecting USB devices to this receiver.

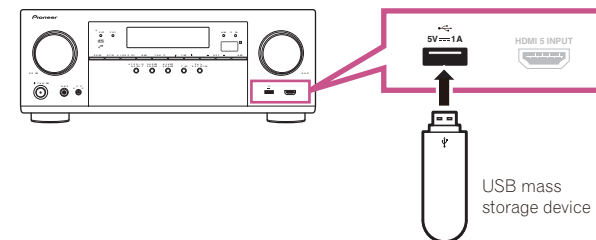

- **Switch the receiver into standby then connect your USB device to the USB terminal on the front panel of this receiver.**
- This receiver does not support a USB hub.
- For instructions on playing the USB device, see [Playing a USB device](#) on [page 46](#).

## Connecting an MHL-compatible device

An MHL-compatible mobile device can be connected to enjoy 3D/Full-HD videos, high quality multi-channel audio, and photos etc., with charge the battery on the receiver. Use the MHL cable to connect the device.

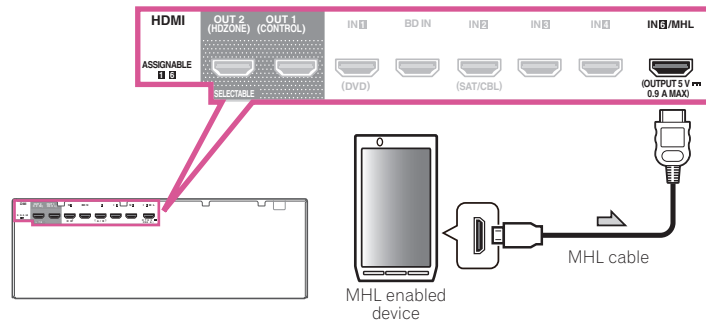

- Switch the receiver into standby then use the MHL cable to connect your MHL enabled device to the MHL terminal on the rear panel of this receiver.
- To automatically switch to the MHL input when an MHL-compatible device is connected, see [MHL Setup](#) on [page 92](#).
- The MHL-compatible device is recharged whenever it is connected to this unit. (Recharging is enabled only when the unit's power is turned on.)
- For instructions on playing the MHL-compatible device, see [Playing an MHL-compatible device](#) on [page 47](#).
- Do not place the MHL device on this unit which has the power turned on.

## Enjoy Roku video streaming service

Connect the Roku Streaming Stick (optional) to the **MHL** terminal on the receiver to enjoy video streaming ([page 47](#)).

- When the Roku Streaming Stick (optional) is connected to the **MHL** terminal of the receiver and the power of the receiver is turned on for the first time, the settings screen is displayed. You can change settings later ([page 92](#)).
- When the Roku Streaming Stick (optional) is inserted, the unit will switch to **MHL** input.

## Connecting an HDMI-equipped component to the front panel input

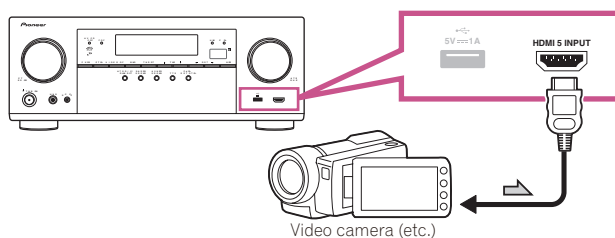

## Connecting to a wireless LAN

Wireless connection to the network is possible through a wireless LAN connection. Use the separately sold AS-WL300 for connection.

- Use only the furnished accessory connecting cable.
- Certain settings are required to use a wireless LAN converter (AS-WL300). For instructions on making these settings, see the operating instructions included with the wireless LAN converter (AS-WL300).

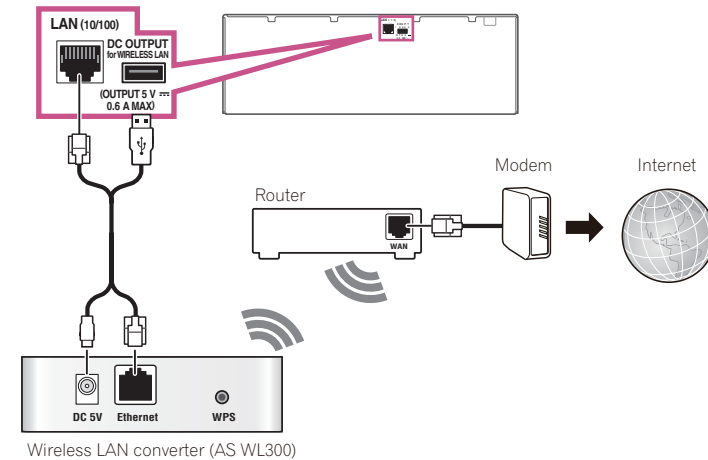

## Connecting an IR receiver

If you keep your stereo components in a closed cabinet or shelving unit, or you wish to use the sub zone remote control in another zone, you can use an optional IR receiver (such as a Niles or Xantech unit) to control your system instead of the remote sensor on the front panel of this receiver.

- Remote operation may not be possible if direct light from a strong fluorescent lamp is shining on the IR receiver remote sensor window.
- Note that other manufacturers may not use the IR terminology. Refer to the manual that came with your component to check for IR compatibility.
- If using two remote controls (at the same time), the IR receiver's remote sensor takes priority over the remote sensor on the front panel.

### 1 Connect the IR receiver sensor to the IR IN jack on the rear of this receiver.

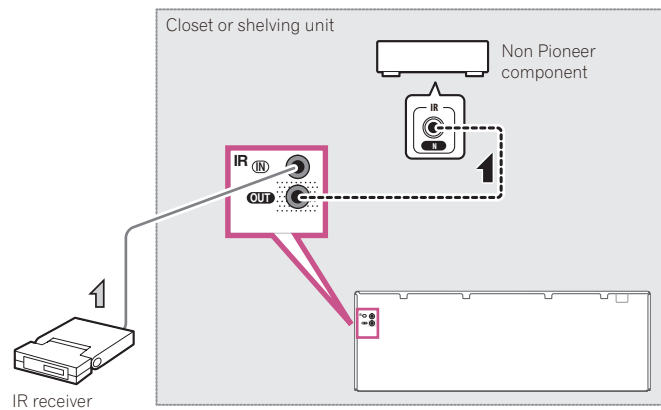

### 2 Connect the IR IN jack of another component to the IR OUT jack on the rear of this receiver to link it to the IR receiver.

Please see the manual supplied with your IR receiver for the type of cable necessary for the connection.

## Plugging in the receiver

Only plug in after you have connected all your components to this receiver, including the speakers.

### ⚠ CAUTION

- Handle the power cord by the plug part. Do not pull out the plug by tugging the cord, and never touch the power cord when your hands are wet, as this could cause a short circuit or electric shock. Do not place the unit, a piece of furniture, or other object on the power cord or pinch the cord in any other way. Never make a knot in the cord or tie it with other cables. The power cords should be routed so that they are not likely to be stepped on. A damaged power cord can cause a fire or give you an electric shock. Check the power cord once in a while. If you find it damaged, ask your nearest Pioneer authorized independent service company for a replacement.
- The receiver should be disconnected by removing the mains plug from the wall socket when not in regular use, e.g., when on vacation.
- **Plug the AC power cord into a convenient AC power outlet.**



## Basic Setup

How to use the built-in AVNavigator .....	37
Automatically conducting optimum sound tuning (Full Auto MCACC) .....	38
The Input Setup menu .....	40
Operation Mode Setup .....	41
Changing the OSD display language (OSD Language) .....	41
About the Home Menu .....	42



## How to use the built-in AVNavigator

The built-in AVNavigator is equipped with **Wiring Navi**, which allows you to perform connection of this receiver and initial settings in interactive mode. By simply following the screen prompts to connect and set the unit, highly accurate initial settings can be performed easily.

Additionally, in order to use various functions easily, contents linked to the receiver can be used.

### Operating Environment

- AVNavigator can be used in the following environments.
  - Windows PC: Microsoft® Windows® XP/Windows Vista®/Windows® 7/Windows® 8/Windows® 8.1
  - Mac OS: Mac OSX (10.7, 10.8 or 10.9)
  - iPad/iPhone/iPod touch: iOS 7
  - Android device: Android 4.0.4
- Some AVNavigator functions use an Internet browser. The following browsers are supported:
  - Windows PC: Internet Explorer® 8, 9, 10, 11
  - Mac OS/iPad/iPhone/iPod touch: Safari 6.0
  - Android device: Android browser
- To use certain AVNavigator functions, you must install the latest Adobe® Flash® Player. For details, visit the following website.  
<http://www.adobe.com/downloads/>
- Depending on the computer network setting or security setting, AVNavigator may not operate.

### Using AVNavigator

**1 Press  $\odot$  STANDBY/ON to switch on the receiver and your computer.**

**2 Launch AVNavigator.**

Operate AVNavigator by following the screen prompts of your computer, etc.

- On a Windows PC, launch Internet Explorer and enter the IP address of this unit in the address field of Internet Explorer. (Access the IP address "http://(the receiver's IP address)" from a web browser.) You can display the IP address of the unit on the unit's display by pressing the **STATUS** button on the remote control.
- With a Windows PC other than Windows XP, you can use the following method to launch AVNavigator. Launch Explorer and right-click <VSX-1124> displayed in the **'Network'** folder, then click **'View device webpage'**.

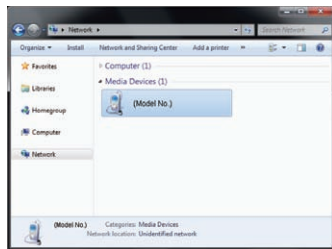

- On a Mac, launch Safari and click <VSX-1124> displayed in **'Bonjour'** on the Bookmarks bar.

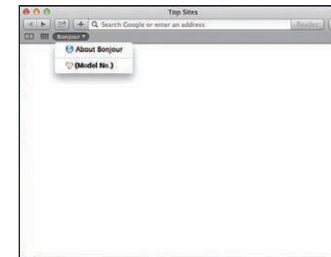

- If **'Bonjour'** is not displayed, tick the **'Include Bonjour in the Favorites bar'** check box on the **'Advanced'** tab in the Safari **'Preferences...'** menu.

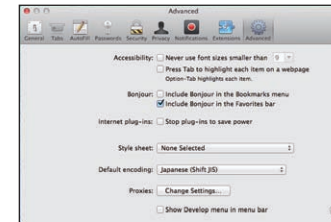

- When using an iPad/iPhone/iPod touch, from the App Store, download iControlAV5, which is a free application. After launching iControlAV5, follow the instructions on the screen. After that, on the Home screen, tap **'AVNavigator'** or the icon.

#### iPad



#### iPhone/iPod touch

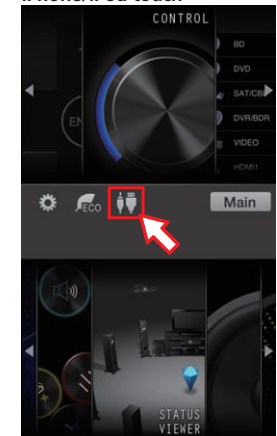

- On an iPad, you can operate AVNavigator for iPad. Download AVNavigator for iPad from the App Store. After launching AVNavigator for iPad, follow the instructions on the screen.



- When using an Android device, from Google Play Store, download iControlAV5, which is a free application. After launching iControlAV5, follow the instructions on the screen. After that, on the Home screen, tap the icon.

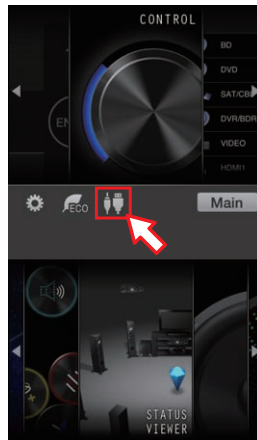

### 3 Select and use the desired function.

AVNavigator includes the following functions:

- Wiring Navi** – Guides you through connections and initial settings in dialog fashion. High precision initial settings can be made easily.
- Interactive Operation Guide** – The receiver will be operated using the remote control on the screen and you can view function explanations or videos. Explanations of the functions that are operated using the remote control are also automatically displayed.
- Network Setup** – Used to make network-related settings.

## Automatically conducting optimum sound tuning (Full Auto MCACC)

The Full Auto MCACC Setup measures the acoustic characteristics of your listening area, taking into account ambient noise, speaker connection and speaker size, and tests for both channel delay and channel level. After you have set up the microphone provided with your system, the receiver uses the information from a series of test tones to optimize the speaker settings and equalization for your particular room.



### Important

- Make sure the microphone and speakers are not moved during the Full Auto MCACC Setup.
- Using the Full Auto MCACC Setup will overwrite any existing settings for the MCACC preset you select.
- Before using the Full Auto MCACC Setup, the headphones should be disconnected.
- The OSD display is only displayed when the receiver's **HDMI OUT 1** terminal and the TV's HDMI input are connected with an HDMI cable. If the TV is connected with anything other than an HDMI cable, watch the front panel display while performing the various operations and making settings.



### CAUTION

- The test tones used in the Full Auto MCACC Setup are output at high volume.

#### 1 Press **STANDBY/ON** to switch on the receiver and your TV.

Make sure that the TV's video input is set to this receiver.

#### 2 Connect the microphone to the MCACC SETUP MIC jack on the front panel.

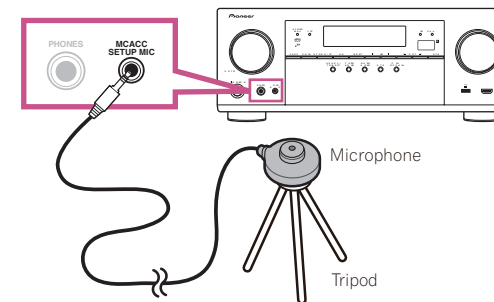

Make sure there are no obstacles between the speakers and the microphone.

If you have a tripod, use it to place the microphone so that it's about ear level at your normal listening position. If you do not have a tripod, use some other object to install the microphone.

Install the microphone on a stable floor. Placing the microphone on any of the following surfaces may make accurate measurement impossible:

- Sofas or other soft surfaces.
- High places such as tabletops and sofa tops.

The Full Auto MCACC display appears once the microphone is connected.

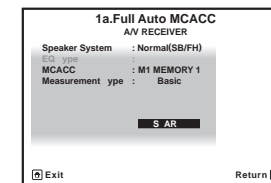

- If you leave the GUI screen for over five minutes, the screen saver will appear.

### 3 Select the parameters you want to set.

If the speakers are connected using any setup other than **Normal(SB/FH)**, be sure to set **Speaker System** before the Full Auto MCACC Setup. See [Speaker system setting](#) on [page 89](#).

- Speaker System** – Shows the current settings. When this is selected and **ENTER** is pressed, the speaker system selection screen appears. Select the proper speaker system, then press **RETURN** to return. If you are planning on bi-amping your front speakers, or setting up a separate speaker system in another room, read through [Speaker system setting](#) on [page 89](#) and make sure to connect your speakers as necessary before continuing to step 4.
- EQ Type** – This determines how the frequency balance is adjusted. Normally select **SYMMETRY**. For details, see [Automatic MCACC \(Expert\)](#) on [page 82](#).
- MCACC** – The six MCACC presets are used for storing surround sound settings for different listening positions. Simply choose an unused preset for now (you can rename it later in [Data Management](#) on [page 87](#)).
- Measurement Type** – When **Basic** is set, the minimum required measurement is performed in a short period of time. When **Expert** is set, accurate and precise measurement is performed so it will take some time.



#### 4 Press MAIN RECEIVER then select START.

#### 5 Follow the instructions on-screen.

Make sure the microphone is connected, and if you're using a subwoofer, make sure it is switched on and set to a comfortable volume level.

#### 6 Wait for the test tones to finish, then confirm the speaker configuration in the GUI screen.

A progress report is displayed on-screen while the receiver outputs test tones to determine the speakers present in your setup. Try to be as quiet as possible while it's doing this.

If no operations are performed for 10 seconds while the speaker configuration check screen is being displayed, the Full Auto MCACC Setup will resume automatically. In this case, you don't need to select 'OK' and press ENTER in step 7.

- With error messages (such as **Too much ambient noise!** or **Check microphone.**), select **RETRY** after checking for ambient noise (see [Problems when using the Auto MCACC Setup](#) on [page 39](#)) and verifying the mic connection. If there doesn't seem to be a problem, you can simply select **GO NEXT** and continue.

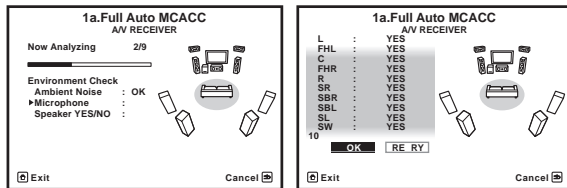

The configuration shown on-screen should reflect the actual speakers you have.

- If you see an **ERR** message (or the speaker configuration displayed isn't correct), there may be a problem with the speaker connection. If selecting **RETRY** doesn't work, turn off the power and check the speaker connections. If there doesn't seem to be a problem, you can simply use **↑/↓** to select the speaker and **←/→** to change the setting and continue.
- If the speaker is not pointed to the microphone (listening position) or when using speakers that affect the phase (dipole speakers, reflective speakers, etc.), **Reverse Phase** may be displayed even if the speakers are properly connected.
  - If **Reverse Phase** is displayed, the speaker's wiring (+ and -) may be inverted. Check the speaker connections.
    - If the connections were wrong, turn off the power, disconnect the power cord, then reconnect properly. After this, perform the Full Auto MCACC procedure again.
    - If the connections were right, select **GO NEXT** and continue.

#### 7 Make sure 'OK' is selected, then press ENTER.

A progress report is displayed on-screen while the receiver outputs more test tones to determine the optimum receiver settings.

Again, try to be as quiet as possible while this is happening. It may take 3 to 10 minutes.

#### 8 The Full Auto MCACC Setup procedure is completed and the Home Menu menu reappears automatically.

Be sure to disconnect the microphone from this receiver upon completion of the Full Auto MCACC Setup. The settings made in the Full Auto MCACC Setup should give you excellent surround sound from your system, but it is also possible to adjust these settings manually using [The Advanced MCACC menu](#) on [page 81](#) or [The System Setup and Other Setup menus](#) on [page 88](#).

- Depending on the characteristics of your room, sometimes identical speakers with cone sizes of around 12 cm (5 inches) will end up with different size settings. You can correct the setting manually using the [Manual speaker setup](#) on [page 89](#).
- The subwoofer distance setting may be farther than the actual distance from the listening position. This setting should be accurate (taking delay and room characteristics into account) and generally does not need to be changed.
- If Full Auto MCACC Setup measurement results are incorrect due to the interaction of the speakers and viewing environment, we recommend adjusting the settings manually.

#### Problems when using the Auto MCACC Setup

If the room environment is not optimal for the Auto MCACC Setup (too much background noise, echo off the walls, obstacles blocking the speakers from the microphone) the final settings may be incorrect. Check for household appliances (air conditioner, fridge, fan, etc.), that may be affecting the environment and switch them off if necessary. If there are any instructions showing in the front panel display, please follow them.

- Some older TVs may interfere with the operation of the microphone. If this seems to be happening, switch off the TV when doing the Auto MCACC Setup.



## The Input Setup menu

You only need to make settings in the **Input Setup** menu if you didn't hook up your digital equipment according to the default settings (see [input function default and possible settings](#) on [page 40](#)). In this case, you need to tell the receiver what equipment is hooked up to which terminal so the buttons on the remote control correspond to the components you've connected.

- The OSD display is only displayed when the receiver's **HDMI OUT 1** terminal and the TV's HDMI input are connected with an HDMI cable. If the TV is connected with anything other than an HDMI cable, watch the front panel display while performing the various operations and making settings.

### 1 Press MAIN RECEIVER to the receiver operation mode, then press HOME MENU.

A Graphical User Interface (GUI) screen appears on your TV. Use **↑/↓/←/→** and **ENTER** to navigate through the screens and select menu items. Press **RETURN** to exit the current menu.

### 2 Select 'System Setup' from the HOME MENU.

### 3 Select 'Input Setup' from the System Setup menu.

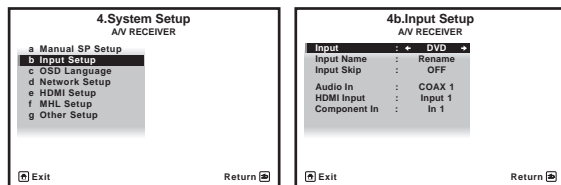

### 4 Select the input function that you want to set up.

The default names correspond with the names next to the terminals on the rear panel (such as **DVD** or **SAT/CBL**) which, in turn, correspond with the names on the remote control.

### 5 Select the input(s) to which you've connected your component.

For example, if your DVD player only has an optical output, you will need to change the **DVD** input function's **Audio In** setting from **COAX-1** (default) to the optical input you've connected it to.

### 6 When you're finished, proceed to the settings for other inputs.

There are optional settings in addition to the assignment of the input jacks:

- Input Name** – You can choose to rename the input function for easier identification. Select **Rename** to do so, or **Default** to return to the system default.
- Input Skip** – When set to **ON**, that input is skipped when selecting the input using **INPUT SELECT**. (**DVD** and other inputs can be still be selected directly with the input function buttons.)

### 7 When you're finished, press RETURN.

You will return to the **System Setup** menu.

## Input function default and possible settings

The terminals on the receiver generally correspond to the name of one of the input functions. If you have connected components to this receiver differently from (or in addition to) the defaults below, see [The Input Setup menu](#) on [page 40](#) to tell the receiver how you've connected up. The dots (●) indicate possible assignments.

Input function	Input Terminals		
	HDMI	Audio	Component
BD	(BD)		
DVD	IN 1	COAX-1	IN 1
SAT/CBL	IN 2	●	
HDMI 1	●		
HDMI 2	●		
HDMI 3			
HDMI 4	IN 3		
HDMI 5 (front panel)	IN 4		
HDMI 6/MHL	IN 5		
INTERNET RADIO	IN 6		
PANDORA			
MEDIA SERVER			
FAVORITES			
iPod/USB			
TV		OPT-1 <a>	
CD		ANALOG-1 <b>	
TUNER			
ADAPTER PORT			

a When **ARC** at **HDMI Setup** is set to **ON**, it is not possible to make assignments to the **TV** input's **Audio In** terminals.

b Only the **TV** and **CD** inputs can be assigned to **ANALOG-1**.



## Operation Mode Setup

This receiver is equipped with a great number of functions and settings. The Operation Mode feature is provided for users who find it difficult to master all these functions and settings.

One of two settings can be selected for the **Operation Mode: Expert** and **Basic**.

- The OSD display is only displayed when the receiver's **HDMI OUT 1** terminal and the TV's HDMI input are connected with an HDMI cable. If the TV is connected with anything other than an HDMI cable, watch the front panel display while performing the various operations and making settings.



### Important

- Many of the settings and functions cannot be selected when the **Operation Mode** is changed to **Basic**.

#### 1 Press MAIN RECEIVER to the receiver operation mode, then press HOME MENU.

A Graphical User Interface (GUI) screen appears on your TV. Use **↑/↓/←/→** and **ENTER** to navigate through the screens and select menu items. Press **RETURN** to exit the current menu.

#### 2 Select 'Operation Mode Setup' from the HOME MENU.

#### 3 Select the Operation Mode setting you want.

- Expert** (default) – Users can set all the functions by themselves.
- Basic** – Only certain basic settings can be operated. The settings that can be operated are shown below. They can be set as necessary by referring to the operating instructions.

Operable settings/items	Descriptions	Page
HOME MENU		
<b>Full Auto MCACC</b>	Makes high precision sound field settings easily.	<a href="#">38</a>
<b>Input Name</b>	Input names can be changed as desired for easier use.	<a href="#">40</a>
<b>Input Skip</b>	Inputs not being used are skipped (not displayed).	<a href="#">40</a>
<b>Software Update</b>	Updates to the latest version of the software.	<a href="#">93</a>
<b>Network Information</b>	Checks the receiver's IP address.	<a href="#">92</a>
Audio Parameters		
<b>MCACC</b> (MCACC preset)	Selects your favorite MCACC preset memory.	<a href="#">67</a>
<b>DELAY</b> (Sound Delay)	Adjusts the delay time of the overall sound.	<a href="#">67</a>
<b>S.RTRV</b> (Auto Sound Retriever)	Plays compressed sound with high sound quality.	<a href="#">67</a>
<b>DUAL</b> (Dual Mono)	Dual monaural audio setting.	<a href="#">67</a>
<b>INPUT ATT</b> (Input attenuate)	Decreases the input signal level to reduce distortion.	<a href="#">67</a>
<b>V.SP</b> (Virtual Speakers)	Automatically complements virtual surround speakers (surround back, front height and front wide) to create a sound field.	<a href="#">67</a>
<b>V.SB</b> (Virtual Surround Back)	Creates a virtual surround back channel sound for playback.	<a href="#">67</a>
<b>V.HEIGHT</b> (Virtual Height)	Creates a virtual height channel sound for playback.	<a href="#">67</a>
<b>V.WIDE</b> (Virtual Wide)	Creates a virtual wide channel sound for playback.	<a href="#">67</a>
<b>V.DEPTH</b> (Virtual Depth)	Plays with a sound field suited for 3D images.	<a href="#">67</a>

Operable settings/items	Descriptions	Page
Other functions		
<b>INPUT SELECT (INPUT SELECTOR)</b>	Switches the input.	<a href="#">44</a>
<b>VOLUME +/-, MUTE</b>	Use to set the listening volume.	<a href="#">44</a>
<b>LISTENING MODE</b>	Selects your favorite listening modes.	<a href="#">51</a>
<b>PQLS</b>	Plays using the PQLS function.	<a href="#">64</a>
<b>PHASE (Phase Control)</b>	Plays with phase shifting in the low range corrected.	<a href="#">54</a>
<b>SOUND RETRIEVER AIR</b>	Switches the input to <b>ADAPTER PORT</b> and plays compressed sound with high sound quality.	<a href="#">50</a>
<b>iPod iPhone DIRECT CONTROL</b>	Switches the input to <b>iPod/USB</b> and sets the mode allowing operation from the iPod.	<a href="#">45</a>

#### 4 When you're finished, press RETURN.

You will return to the **HOME MENU**.

## Changing the OSD display language (OSD Language)

The language used on the Graphical User Interface screen can be changed.

- The explanations in these operating instructions are for when English is selected for the GUI screen.
- The OSD display is only displayed when the receiver's **HDMI OUT 1** terminal and the TV's HDMI input are connected with an HDMI cable. If the TV is connected with anything other than an HDMI cable, watch the front panel display while performing the various operations and making settings.

#### 1 Press **⏻** STANDBY/ON to switch on the receiver and your TV.

Make sure that the TV's video input is set to this receiver (for example, if you connected this receiver to the **VIDEO** jacks on your TV, make sure that the **VIDEO** input is now selected).

#### 2 Press MAIN RECEIVER to the receiver operation mode, then press HOME MENU.

A Graphical User Interface (GUI) screen appears on your TV. Use **↑/↓/←/→** and **ENTER** to navigate through the screens and select menu items. Press **RETURN** to exit the current menu.

#### 3 Select 'System Setup' from the Home Menu.

#### 4 Select 'OSD Language' from the System Setup menu.

#### 5 Select the desired language.

#### 6 Select 'OK' to change the language.

The setting is completed and the **System Setup** menu reappears automatically.



## About the Home Menu

This receiver's Home Menu (**HOME MENU**) can be used to make various settings and to check and adjust items that have been set.

- The OSD display is only displayed when the receiver's **HDMI OUT 1** terminal and the TV's HDMI input are connected with an HDMI cable. If the TV is connected with anything other than an HDMI cable, watch the front panel display while performing the various operations and making settings.

- 1 Press **MAIN RECEIVER** to the receiver operation mode, then press **HOME MENU**.
- 2 To display the Home Menu screen, press **HOME MENU** on the remote control.

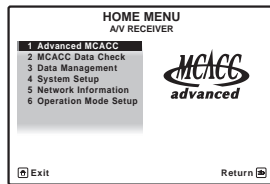

A Graphical User Interface (GUI) screen appears on your TV. Use **↑/↓/←/→** and **ENTER** to navigate through the screens and select menu items. Press **RETURN** to exit the current menu.

The top level in the Home Menu is as shown below. Refer to the respective explanations to set, check and adjust as necessary.

- **Advanced MCACC** – Use this to make automatic settings and detailed manual settings for the surround sound. For details, see [Making receiver settings from the Advanced MCACC menu](#) on [page 82](#).
- **MCACC Data Check** – This displays the Advanced MCACC measurement results. Use it to check the MCACC memory. For details, see [Checking MCACC Data](#) on [page 86](#).
- **Data Management** – Use this to manage the data in the MCACC memory. For details, see [Data Management](#) on [page 87](#).
- **System Setup** – Use this to make various settings related to this system. For details, see [Making receiver settings from the System Setup menu](#) on [page 89](#).
- **Network Information** – The setting status of the network-related items can be checked. For detail, see [Checking the Network Information](#) on [page 92](#).
- **Operation Mode Setup** – Use this to select this receiver's operation mode. For details, see [Operation Mode Setup](#) on [page 41](#).





## Basic playback

Playing a source .....	44
Playing an iPod .....	45
Playing a USB device .....	46
Playing an MHL-compatible device .....	47
Listening to the radio .....	48
<i>Bluetooth</i> ADAPTER for Wireless Enjoyment of Music .....	49



## Playing a source

Here are the basic instructions for playing a source (such as a DVD disc) with your home theater system.

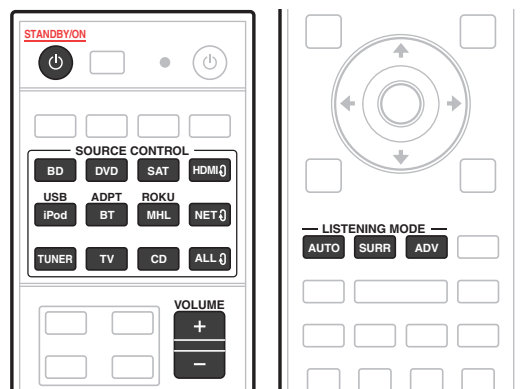

### 1 Switch on your system components and receiver.

Start by switching on the playback component (for example a DVD player), your TV and subwoofer (if you have one), then the receiver (press **STANDBY/ON**).

Make sure that the TV's video input is set to this receiver.

### 2 Select the input function you want to play.

You can use the input function buttons on the remote control or the front panel **INPUT SELECTOR** dial.

- As necessary, select the type of audio input signal ([page 54](#)).

### 3 Press **AUTO (AUTO SURR/ALC/STREAM DIRECT)** to select 'AUTO SURROUND' and start playback of the source.

For such sound sources as Dolby TrueHD and DTS-HD, the surround sound is played. With stereo sound, the sound is played from the left and right front speakers with the default listening mode.

To play a stereo sound source in multichannel, press **SURR** or **ADV** to select your favorite listening mode.

(Example: Press **ADV** several times to select **EXT.STEREO**.)

- You may need to check the digital audio output settings on your DVD player or digital satellite receiver. It should be set to output Dolby Digital, DTS and 88.2 kHz / 96 kHz PCM (2 channel) audio, and if there is an MPEG audio option, set this to convert the MPEG audio to PCM.
- See also [Listening to your system](#) on [page 51](#) for information on different ways of listening to sources.

It is possible to check on the front panel display whether or not multi-channel playback is being performed properly. For details, see [Auto Surround, ALC and Stream Direct with different input signal formats](#) on [page 111](#).

When multi-channel speakers (more than the two front left and right channels) are connected, straight decoding is performed, so the input signal's format name (for example, **TrueHD**, **DTS-HD MSTR** or **DTS-HD HI RES**) is displayed.

If the display does not correspond to the input signal and listening mode, check the connections and settings.

### 4 Use the **VOLUME +/-** to adjust the volume level.

Turn down the volume of your TV so that all sound is coming from the speakers connected to this receiver.



#### Note

Depending on the input to be played, the playback operation can in some cases be performed using the on-screen display.

The OSD display is only displayed when the receiver's **HDMI OUT 1** terminal and the TV's HDMI input are connected with an HDMI cable. If the TV is connected with anything other than an HDMI cable, watch the front panel display while performing the various operations and making settings.

## Turning off the sound

Mutes the sound or restores the sound if it has been muted (adjusting the volume also restores the sound).

- Press **MUTE**.

## Playing a source with HDMI connection

- Use **INPUT SELECT** to select the input function connected to the receiver's HDMI input terminals.

You can also perform the same operation by using the **INPUT SELECTOR** dial on the front panel or by pressing **HDMI** on the remote control repeatedly.

- Set the **HDMI** parameter in [Setting the Audio options](#) on [page 67](#) to **THROUGH** if you want to hear HDMI audio output from your TV (no sound will be heard from this receiver).
- If the video signal does not appear on your TV, try adjusting the resolution settings on your component or display. Note that some components (such as video game units) have resolutions that may not be converted. In this case, use an analog video connection.



## Playing an iPod

This receiver has the **iPod/iPhone** terminal that will allow you to control playback of audio content from your iPod using the controls of this receiver.

Here we describe the procedure for playback on an iPod. For playback on a USB device, see [Playing a USB device](#) on [page 46](#).



### Important

- USB works with iPhone 5s, iPhone 5c, iPhone 5, iPhone 4s, iPhone 4, iPhone 3GS, iPhone 3G, iPhone, iPod touch (1st through 5th generation) and iPod nano (3rd through 7th generation). However, some of the functions may be restricted for some models.
- This receiver has been developed and tested for the software version of iPod/iPhone indicated on the website of Pioneer.  
<http://pioneer.jp/homeav/support/ios/na/>
- Installing software versions other than indicated on the website of Pioneer to your iPod/iPhone may result in incompatibility with this receiver.
- iPod and iPhone are licensed for reproduction of non-copyrighted materials or materials the user is legally permitted to reproduce.
- Features such as the equalizer cannot be controlled using this receiver, and we recommend switching the equalizer off before connecting.
- Pioneer cannot under any circumstances accept responsibility for any direct or indirect loss arising from any inconvenience or loss of recorded material resulting from the iPod failure.
- When listening to a track on the iPod in the main zone, it is possible to control the sub zone, but not to listen to a different track in the sub zone from the one playing in the main zone.

### 1 Press **STANDBY/ON** to switch on the receiver and your TV.

See [Connecting an iPod](#) on [page 33](#).

About one minute is required between turning the power on and completion of startup.

- It is also possible to operate the iPod on the iPod itself, without using the TV screen. For details, see [Switching the iPod controls](#) on [page 45](#).

### 2 Press **iPod USB** on the remote control to switch the receiver to the iPod/USB.

When the display shows the names of folders and files, you're ready to play music from the iPod.

- The controls of your iPod will be inoperable when connected to this receiver.

## Playing back audio files stored on an iPod

To navigate songs on your iPod, you can take advantage of the GUI screen of your TV connected to this receiver. You can also control all operations for music in the front panel display of this receiver.

- Note that characters that cannot be displayed on this receiver are displayed as #.
- This feature is not available for photos on your iPod. To display photos, switch iPod operation to the iPod (see [Switching the iPod controls](#) on [page 45](#)).

### Finding what you want to play

When your iPod is connected to this receiver, you can browse songs stored on your iPod by playlist, artist name, album name, song name, genre or composer, similar to using your iPod directly.

#### 1 Use **↑/↓** to select a category, then press **ENTER** to browse that category.

- When **◀▶** or **▶▶** is pressed at the list screen, the page switches.
- To return to the previous level any time, press **RETURN**.

#### 2 Use **↑/↓** to browse the selected category (e.g., albums).

- Use **◀▶** to move to previous/next levels.

#### 3 Continue browsing until you arrive at what you want to play, then press **▶** to start playback.

- On the playback screen, pressing **RETURN** displays a list screen. To return to the playback screen, press **DISP**.



### Note

You can play all of the songs in a particular category by selecting the **All** item at the top of each category list. For example, you can play all the songs by a particular artist.

### Basic playback controls

This receiver's remote control buttons can be used for basic playback of files stored on an iPod.

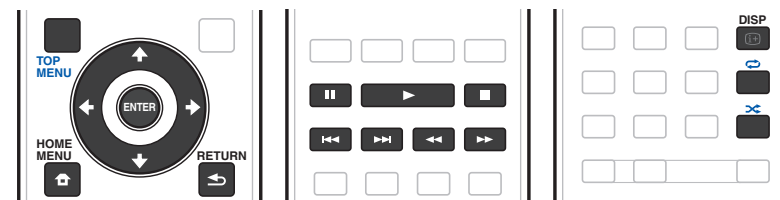

### Switching the iPod controls

You can switch over the iPod controls between the iPod and the receiver.

#### 1 Press **HOME MENU** to switch the iPod controls.

This enables operation and display on your iPod, and this receiver's remote control and GUI screen become inactive.

#### 2 Press **HOME MENU** again to switch back to the receiver controls.



### Note

Change the receiver's input to the iPod in one action by pressing the **iPod iPhone DIRECT CONTROL** button on the front panel to enable iPod operations on the iPod.



## Playing a USB device

It is possible to play files using the USB interface on the front of this receiver.

- Compatible USB devices include external magnetic hard drives, portable flash memory drives (particularly key drives) and digital audio players (MP3 players) of format FAT16/32.
- Pioneer cannot guarantee compatibility (operation and/or bus power) with all USB mass storage devices and assumes no responsibility for any loss of data that may occur when connected to this receiver.

### 1 Press **STANDBY/ON** to switch on the receiver and your TV.

See [Connecting a USB device](#) on [page 33](#).

About one minute is required between turning the power on and completion of startup.

- Make sure the receiver is in standby when disconnecting the USB device.

### 2 Press **iPod USB** on the remote control to switch the receiver to the iPod/USB.

When the display shows the names of folders and files, you're ready to play from the USB device.



#### Note

If an **Over Current** message lights in the display, the power requirements of the USB device are too high for this receiver. Try following the points below:

- Switch the receiver off, then on again.
- Reconnect the USB device with the receiver switched off.
- Use a dedicated AC adapter (supplied with the device) for USB power.

If this doesn't remedy the problem, it is likely your USB device is incompatible.

## Playing back audio files stored on a USB memory device

The maximum number of levels that you can select in Step 2 (below) is 9.

- Note that non-Roman characters in the playlist are displayed as #.

### 1 Use **↑/↓** to select a folder, then press **ENTER** to browse that folder.

- To return to the previous level any time, press **RETURN**.

### 2 Continue browsing until you arrive at what you want to play, then press **▶** to start playback.

- Copyrighted audio files cannot be played back on this receiver.
- DRM-protected audio files cannot be played back on this receiver.
- On the playback screen, pressing **RETURN** displays a list screen. To return to the playback screen, press **DISP**.

## Basic playback controls

This receiver's remote control buttons can be used for basic playback of files stored on USB memory devices.

- Press **iPod USB** to switch the remote control to the iPod/USB operation mode.

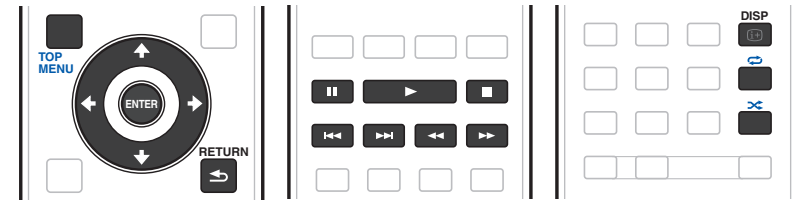

#### Note

While a DSD file is being played, **◀◀** and **▶▶** are disabled.

## Playing back photo files stored on a USB memory device

- Photo files cannot be played in the sub zone.

### 1 Use **↑/↓** to select a folder, then press **ENTER** to browse that folder.

- For high resolution files, some time may be required for the photo to appear.
- To return to the previous level any time, press **RETURN**.

### 2 Continue browsing until you arrive at what you want to play, then press **ENTER** to start playback.

The selected content is displayed in full screen and a slideshow starts.

## Basic playback controls

Button(s)	What it does
<b>ENTER</b> ▶	Starts displaying a photo and playing a slideshow.
■	Stops the player and returns to the previous menu.



#### Tip

- Slideshows of photo files can be played while listening to music files by returning to the folder/file list display while playing a music file on a USB device then playing the photo files.



## About playable file formats

The USB function of this receiver supports the following file formats. Note that some file formats are not available for playback although they are listed as playable file formats.

- With MP3, WAV, AAC, FLAC, AIFF and Apple Lossless files, when music files with the same format, sampling frequency, quantization bit number and number of channels are played successively, they are played with no gap.
- When AAC or MP3 format is used, sound is reproduced with the minimum gap. If you are conscious about gaps, use WAV or FLAC files.

## Music files

Category	Extension		Stream	
MP3 <a>	.mp3	MPEG-1 Audio Layer-3	Sampling frequency	32 kHz, 44.1 kHz, 48 kHz
			Quantization bitrate	16 bit
			Channel	2 ch
			Bitrate	8 kbps to 320 kbps
			VBR/CBR	Supported/Supported
WAV	wav	LPCM	Sampling frequency <b>	32 kHz, 44.1 kHz, 48 kHz, 88.2 kHz, 96 kHz, 176.4 kHz, 192 kHz
			Quantization bitrate	16 bit, 24 bit
			Channel	2 ch, 5.0 ch, 5.1 ch <c>
			Channel	2 ch, 5.0 ch, 5.1 ch <c>
WMA	.wma	WMA2/7/8/9 <d>	Sampling frequency	32 kHz, 44.1 kHz, 48 kHz
			Quantization bitrate	16 bit
			Channel	2 ch
			Bitrate	5 kbps to 320 kbps
			VBR/CBR	Supported/Supported
AAC	.m4a .aac .3gp .3g2	MPEG-4 AAC LC MPEG-4 HE AAC	Sampling frequency	32 kHz, 44.1 kHz, 48 kHz
			Quantization bitrate	16 bit
			Channel	2 ch
			Bitrate	16 kbps to 320 kbps
			VBR/CBR	Supported/Supported
Apple Lossless	.m4a .mp4	Apple Lossless	Sampling frequency	32 kHz, 44.1 kHz, 48 kHz, 88.2 kHz, 96 kHz
			Quantization bitrate	16 bit, 24 bit
			Channel	2 ch
FLAC <e>	.flac	FLAC	Sampling frequency <b>	32 kHz, 44.1 kHz, 48 kHz, 88.2 kHz, 96 kHz, 176.4 kHz, 192 kHz
			Quantization bitrate	16 bit, 24 bit
			Channel	2 ch, 5.0 ch, 5.1 ch <c>
AIFF	aiff aif	AIFF	Sampling frequency	32 kHz, 44.1 kHz, 48 kHz, 88.2 kHz, 96 kHz, 176.4 kHz, 192 kHz
			Quantization bitrate	16 bit, 24 bit
			Channel	2 ch

Category	Extension		Stream	
DSD <f>	.dff .dsf	DSDIFF DSF	Sampling frequency	2.8224 MHz
			Quantization bitrate	1 bit
			Channel	2 ch

a "MPEG Layer-3 audio decoding technology licensed from Fraunhofer IIS and Thomson multimedia."

b 176.4 kHz and 192 kHz support 2-channel audio sources only.

c Gapless playback is not possible with a 5.0-channel or 5.1-channel audio source.

d Files encoded using Windows Media Codec 9 may be playable but some parts of the specification are not supported; specifically, Pro, Lossless, Voice.

e Uncompressed FLAC files are not supported. Pioneer does not guarantee playback.

f DSD files cannot be played in the sub zone.

## Photo files

Category	Extension	Format
JPEG	.jpg	Meeting the following conditions: <ul style="list-style-type: none"> <li>• Baseline JPEG format</li> <li>• Y:Cb:Cr – 4 2 2</li> </ul>

## Playing an MHL-compatible device

MHL (Mobile High-definition Link) is an interface standard for transmitting digital signals with mobile devices. MHL can carry high quality multi-channel audio data and 3D/Full-HD video formats.

The MHL-compatible device's video signals are output from the TV connected to the receiver, the audio signals are output from the speakers connected to the receiver or TV.

### 1 Press STANDBY/ON to switch on the receiver and your TV.

See [Connecting an MHL-compatible device](#) on [page 34](#).

### 2 Press MHL on the remote control to switch the receiver to the MHL.

### 3 Select and play the desired contents on the MHL-compatible device.



#### Notes

- MHL-compatible devices can be operated with the receiver's remote control by pressing the remote control's **MHL** button, but depending on the MHL-compatible device being used, some buttons may not be operable.
- To playback from a MHL-compatible device connected to the receiver on a TV that is also connected to the receiver, the power to the receiver must be turned on.

## Enjoy Roku video streaming service

Connect the Roku Streaming Stick (optional) to the **MHL** terminal on the main device to enjoy video streaming.

### 1 Press STANDBY/ON to switch on the receiver and your TV.

See [Connecting an MHL-compatible device](#) on [page 34](#).

### 2 Press MHL on the remote control to switch the receiver to the MHL.

### 3 Select the contents you want to play and playback.



#### Note

When the Roku Streaming Stick (optional) is connected to the **MHL** terminal of the receiver and the power of the receiver is turned on for the first time, the settings screen is displayed. You can change settings later ([page 92](#)).

## Listening to the radio

The following steps show you how to tune in to FM and AM radio broadcasts using the automatic (search) and manual (step) tuning functions. If you already know the frequency of the station you want, see [Tuning directly to a station](#) below. Once you are tuned to a station you can memorize the frequency for recall later—see [Saving station presets](#) on [page 48](#) for more on how to do this.

- 1 Press **TUNER** to select the tuner.
- 2 Use **BAND** to change the band (FM or AM), if necessary.
- 3 Tune to a station.

There are three ways to do this:

- **Automatic tuning** – To search for stations in the currently selected band, press and hold **TUNE +/-** for about a second. The receiver will start searching for the next station, stopping when it has found one. Repeat to search for other stations.
- **Manual tuning** – To change the frequency one step at a time, press **TUNE +/-**.
- **High speed tuning** – Press and hold **TUNE +/-** for high speed tuning. Release the button at the frequency you want.

## Improving FM sound

If the **TUNED** or **STEREO** indicator doesn't light when tuning to an FM station because the signal is weak, press **MPX** to switch the receiver into mono reception mode. This should improve the sound quality and allow you to enjoy the broadcast.

## Tuning directly to a station

- 1 Press **TUNER** to select the tuner.
- 2 Use **BAND** to change the band (FM or AM), if necessary.
- 3 Press **D.ACCESS (Direct Access)**.
- 4 Use the number buttons to enter the frequency of the radio station.

For example, to tune to **106.00** (FM), press **1, 0, 6, 0, 0**.

If you make a mistake halfway through, press **D.ACCESS** twice to cancel the frequency and start over.

## Saving station presets

If you often listen to a particular radio station, it's convenient to have the receiver store the frequency for easy recall whenever you want to listen to that station. This saves the effort of manually tuning in each time. This receiver can memorize up to 63 stations, stored in seven banks, or classes (A to G) of 9 stations each.

- 1 **Tune to a station you want to memorize.**  
See [Listening to the radio](#) on [page 48](#) for more on this.
- 2 Press **TOOLS (TUNER EDIT)**.  
The display shows **PRESET MEMORY**, then a blinking memory class.
- 3 Press **CLASS** to select one of the seven classes, then press **PRESET +/-** to select the station preset you want.

You can also use the number buttons to select a station preset.

- 4 Press **ENTER**.

After pressing **ENTER**, the preset class and number stop blinking and the receiver stores the station.

## Listening to station presets

- 1 Press **TUNER** to select the tuner.
- 2 Press **CLASS** to select the class in which the station is stored.  
Press repeatedly to cycle through classes A to G.
- 3 Press **PRESET +/-** to select the station preset you want.
  - You can also use the number buttons on the remote control to recall the station preset.

## Naming station presets

For easier identification, you can name your station presets.

- 1 **Choose the station preset you want to name.**  
See [Listening to station presets](#) on [page 48](#) for how to do this.
- 2 Press **TOOLS (TUNER EDIT)**.  
The display shows **PRESET NAME**, then a blinking cursor at the first character position.
- 3 **Input the name you want.**

Use **↑/↓** (or **TUNE ↑/↓** of front panel) to select a character, **←/→** (or **PRESET ←/→** of front panel) to set the position, and **ENTER** to confirm your selection.



### Notes

- To erase a station name, simply repeat steps 1 to 3 and input eight spaces instead of a name.
- Once you have named a station preset, you can press **DISP** when listening to a station to switch the display between name and frequency.





## Bluetooth ADAPTER for Wireless Enjoyment of Music

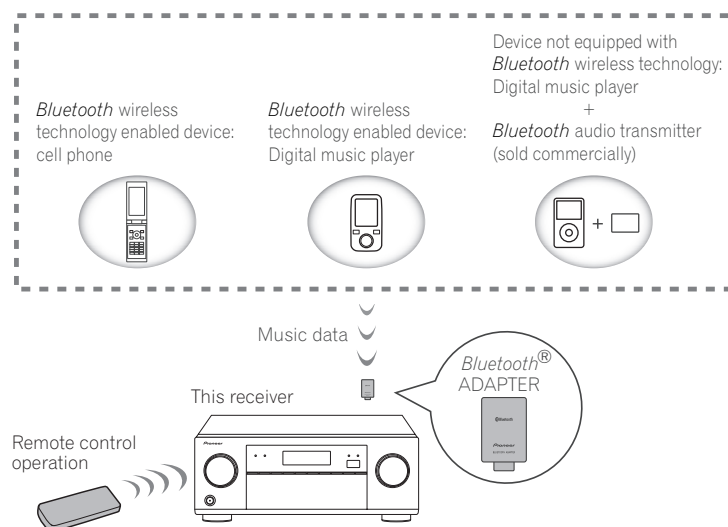

- About one minute is required between turning the power on and completion of startup.

### Wireless music play

When the *Bluetooth* ADAPTER (AS-BT100 or AS-BT200) is connected to this unit, a product equipped with *Bluetooth* wireless technology (portable cell phone, digital music player, etc.) can be used to listen to music wirelessly. Also, by using a commercially available transmitter supporting *Bluetooth* wireless technology, you can listen to music on a device not equipped with *Bluetooth* wireless technology. The AS-BT100 and AS-BT200 models supports SCMS-T contents protection, so music can also be enjoyed on devices equipped with SCMS-T type *Bluetooth* wireless technology.

### Remote control operation

The remote control supplied with this unit allows you to play and stop media, and perform other operations.

- It must be necessary that the *Bluetooth* wireless technology enabled device supports AVRCP profiles.
- Remote control operations cannot be guaranteed for all *Bluetooth* wireless technology enabled devices.

## Pairing the *Bluetooth* ADAPTER and *Bluetooth* wireless technology device

"Pairing" must be done before you start playback of *Bluetooth* wireless technology content using the *Bluetooth* ADAPTER. Make sure to perform pairing the first time you operate the system or any time pairing data is cleared. The pairing step is necessary to register the *Bluetooth* wireless technology device to enable *Bluetooth* communications. For more details, see also the operating instructions of your *Bluetooth* wireless technology device.

- Pairing is required when you first use the *Bluetooth* wireless technology device and *Bluetooth* ADAPTER.
- To enable *Bluetooth* communication, pairing should be done with both your system and *Bluetooth* wireless technology device.
- If the *Bluetooth* wireless technology device's security code is "0000", there is no need to make the security code setting on the receiver. Press **ADPT** to set the **ADAPTER PORT** input, then conduct the pairing operation on the *Bluetooth* wireless technology device. If pairing is successful, there is no need to performing the pairing operation below.
- When using the AS-BT200 only: This unit complies with *Bluetooth* Specifications Ver. 2.1. When this unit and another device equipped with *Bluetooth* wireless technology both comply with *Bluetooth* Specification Ver. 2.1, pairing of the two may be possible without the need for inputting a password. In this case, a passcode may be displayed on this receiver and on the device equipped with *Bluetooth* wireless technology. If this happens, check that the same passcode is displayed on this receiver and the device equipped with *Bluetooth* wireless technology, then press **ENTER**. After this, also perform the connection operation on the *Bluetooth* device to be connected. If the passcode does not match the code displayed on the *Bluetooth* device to be connected, press **RETURN** to cancel pairing, then try starting over. Press **ADPT** to set the **ADAPTER PORT** input, then conduct the pairing operation on the *Bluetooth* wireless technology device. If pairing is successful, there is no need to performing the pairing operation below.
- Pair one unit at a time.
- When connecting this receiver by *Bluetooth* connections with a device equipped with the *Bluetooth* function to listen to music, do not connect any devices other than this receiver by *Bluetooth* connection to the *Bluetooth*-equipped device. If a *Bluetooth* connection is already established with a device other than this receiver, disconnect the other device before connecting this receiver.

- 1 Press **ADPT** on the remote control to switch the receiver to **ADAPTER PORT** input.
- 2 Press **TOP MENU** to select **Bluetooth Setup**.
- 3 Use **↑/↓** to select '**PIN**' then press **ENTER**.
- 4 Use **↑/↓** to select one of PIN codes **0000**, **1234** or **8888**, then press **ENTER**.  
You can use any of **0000**, **1234** or **8888** PIN codes. *Bluetooth* wireless technology device using any other PIN code cannot be used with this receiver.
- 5 Press the **RETURN** button twice to exit **Bluetooth Setup**.
- 6 Switch on the *Bluetooth* wireless technology device that you want to make pair, place it near the receiver and set it to the pairing mode.
- 7 From the *Bluetooth* wireless technology device list, select *Bluetooth* ADAPTER and enter the PIN code selected in step 4.
- 8 Check to see that the *Bluetooth* ADAPTER is detected by the *Bluetooth* wireless technology device.

If the receiver and *Bluetooth* wireless technology device are not paired, start over from step 6.



### Notes

- The PIN code may in some cases be referred to as PASSKEY.
- For information on enabling pairing on the *Bluetooth* wireless technology device, connection procedures, etc., see the *Bluetooth* wireless technology device's operating instructions.



## Listening to music contents of a *Bluetooth* wireless technology device with your system

- 1 Press **ADPT** on the remote control to switch the receiver to **ADAPTER PORT** input.
- 2 From the *Bluetooth* wireless technology device, perform the operation to connect to the *Bluetooth* **ADAPTER**.

- When the *Bluetooth* **ADAPTER** is not plugged into the **ADAPTER PORT**, **No Adapter** will be displayed if **ADAPTER PORT** input is selected.

- 3 **Start playback of music contents stored on the *Bluetooth* wireless technology device.**

This receiver's remote control buttons can be used for basic playback of files stored on *Bluetooth* wireless technology devices.

- *Bluetooth* wireless technology device should be compatible with AVRCP profile.
- Depending on the *Bluetooth* wireless technology device you use, operation may differ from what is shown in the remote control buttons.

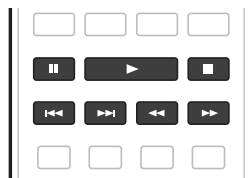

- 4 While listening to a source, set the remote control to the receiver operation mode, then press **ADV** repeatedly to select **SOUND RETRIEVER AIR**.



### Notes

- The *Bluetooth*® word mark and logos are registered trademarks owned by Bluetooth SIG, Inc. and any use of such marks by PIONEER CORPORATION is under license. Other trademarks and trade names are those of their respective owners.
- With this receiver, when an iPod is connected or disconnected while the music of a *Bluetooth* wireless technology device is playing, the connection with the *Bluetooth* wireless technology device may be canceled.
- The **SOUND RETRIEVER AIR** listening mode can only be selected when the **ADAPTER PORT** input.





## Listening to your system

Enjoying various types of playback using the listening modes .....	52
Selecting MCACC presets .....	54
Choosing the input signal .....	54
Better sound using Phase Control .....	54



## Enjoying various types of playback using the listening modes

Using this receiver, you can listen to any source in surround sound. However, the options available will depend on your speaker setup and the type of source you're listening to.

To play with surround sound, check "[Standard surround sound](#)" or "[Using the Advanced surround effects](#)" below and select the desired mode.

To play with the optimum mode for the input signal, see "[Auto playback](#)" or "[Using Stream Direct](#)". (The sound is played in stereo when 2-channel signals are input, in surround when multi-channel signals are input.)



### Important

- The listening modes and many features described in this section may not be available depending on the current source, settings and status of the receiver.

## Auto playback

There are many ways to listen back to sources using this receiver, but the simplest, most direct listening option is the Auto Surround feature. The receiver automatically detects what kind of source you're playing and selects multichannel or stereo playback as necessary.

- While listening to a source, press **AUTO (AUTO SURR/ALC/STREAM DIRECT)** for auto playback of a source.

**AUTO SURROUND** shows briefly in the display before showing the decoding or playback format. Check the digital format indicators in the front panel display to see how the source is being processed.

- If the source is Dolby Digital, DTS, or Dolby Surround encoded, the proper decoding format will automatically be selected and shows in the display.
- When listening to the **ADAPTER PORT** input, the **SOUND RETRIEVER AIR** feature is selected automatically.

**ALC** – In the Auto level control (**ALC**) mode, this receiver equalizes playback sound levels.

Also, the low and high frequency sounds, dialogs, surround effects, etc., that are difficult to hear when the volume is low are adjusted to be optimal for the volume level. This mode is particularly optimum when listening at night.



### Note

When **ALC** is selected, the effect level can be adjusted using the **EFFECT** parameter in [Setting the Audio options](#) on [page 67](#).

## Standard surround sound

The following modes provide basic surround sound for stereo and multichannel sources.

- While listening to a source, press **SURR (STANDARD SURROUND)**.

If necessary, press repeatedly to select a listening mode.

- If the source is Dolby Digital, DTS, or Dolby Surround encoded, the proper decoding format will automatically be selected and shows in the display.
- When only one surround back speaker is connected (set), even though a 5.1-channel signal is input, **Pro Logic IIx** cannot be selected and **Pro Logic II** is used.
- Pro Logic IIz HEIGHT** cannot be selected when no front height speaker is connected. Furthermore, **WIDE SURROUND MOVIE** and **WIDE SURROUND MUSIC** cannot be selected when no front wide speaker is connected.

With two channel sources, you can select from:

- Pro Logic IIx MOVIE** – Up to 7.1 channel sound (surround back), especially suited to movie sources
- Pro Logic IIx MUSIC** – Up to 7.1 channel sound (surround back), especially suited to music sources
- Pro Logic IIx GAME** – Up to 7.1 channel sound (surround back), especially suited to video games
- PRO LOGIC** – 4.1 channel surround sound (sound from the surround speakers is mono)
- Pro Logic IIz HEIGHT** – Up to 7.1 channel sound (front height)
- WIDE SURROUND MOVIE** – Up to 7.1 channel sound (front wide), especially suited to movie sources
- WIDE SURROUND MUSIC** – Up to 7.1 channel sound (front wide), especially suited to music sources
- Neo:X CINEMA** – Up to 7.1 channel sound (surround back, front height or front wide), especially suited to movie sources
- Neo:X MUSIC** – Up to 7.1 channel sound (surround back, front height or front wide), especially suited to music sources
- Neo:X GAME** – Up to 7.1 channel sound (surround back, front height or front wide), especially suited to video games
- STEREO** – The audio is heard with your sound settings and you can still use the audio options.

With multichannel sources, if you have connected surround back, front height or front wide speakers, you can select (according to format):

- Pro Logic IIx MOVIE** – See above
- Pro Logic IIx MUSIC** – See above
- Dolby Digital EX** – Creates surround back channel sound for 5.1 channel sources and provides pure decoding for 6.1 channel sources (like Dolby Digital Surround EX)
- DTS-ES Matrix** or **DTS-ES Discrete** – Allows you to hear 6.1 channel playback with DTS-ES encoded sources
- Neo:X CINEMA** – See above
- Neo:X MUSIC** – See above
- Neo:X GAME** – See above
- Pro Logic IIz HEIGHT** – See above
- WIDE SURROUND MOVIE** – See above
- WIDE SURROUND MUSIC** – See above
- STEREO** – See above
- Straight Decode – Plays back without the effects above.



### Notes

- When listening sources in **Pro Logic IIz HEIGHT** mode, you can also adjust the **H.GAIN** effect (see [Setting the Audio options](#) on [page 67](#)).
- When listening to 2-channel sources in Dolby Pro Logic IIx Music mode, there are three further parameters you can adjust: **C.WIDTH**, **DIMENSION** and **PANORAMA**. See [Setting the Audio options](#) on [page 67](#) to adjust them.
- When listening to 2-channel sources in Neo:X Cinema, Neo:X Music or Neo:X Game mode, you can also adjust the **C.GAIN** effect (see [Setting the Audio options](#) on [page 67](#)).
- When listening through headphones, you can select **STEREO** mode only.



## Using the Advanced surround effects

The Advanced surround effects can be used for a variety of additional surround sound effects. Most Advanced Surround modes are designed to be used with film soundtracks, but some modes are also suited for music sources. Try different settings with various soundtracks to see which you like.

- **Press ADV (ADVANCED SURROUND) repeatedly to select a listening mode.**
- **ACTION** – Designed for action movies with dynamic soundtracks
- **DRAMA** – Designed for movies with lots of dialog
- **ADVANCED GAME** – Suitable for video games
- **SPORTS** – Suitable for sports programs
- **CLASSICAL** – Gives a large concert hall-type sound
- **ROCK/POP** – Creates a live concert sound for rock and/or pop music
- **EXT.STEREO** – Gives multichannel sound to a stereo source, using all of your speakers
- **F.S.SURROUND** – Use to provide a rich surround sound effect directed to the center of where the front left and right speakers sound projection area converges.

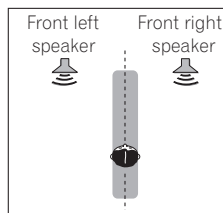

- **SOUND RETRIEVER AIR** – Suitable for listening to the sound from a *Bluetooth* wireless technology device. The **SOUND RETRIEVER AIR** listening mode can only be selected when the **ADAPTER PORT** input.
- **PHONES SURR** – When listening through headphones, you can still get the effect of overall surround.
- **ECO MODE 1** – Select this to play for example music that has a high audio level with a lower power consumption than usual.
- **ECO MODE 2** – Select this to play movies, etc., with a high ratio of low volume scenes and high volume scenes (a large dynamic ratio) with a lower power consumption than usual. This mode provides greater power savings than **ECO MODE 1**.



### Notes

- The Front Stage Surround Advance (**F.S.SURROUND**) function allows you to create natural surround sound effects using just the front speakers and the subwoofer.
- When **ECO MODE 1** or **ECO MODE 2** is selected, the front panel's display lights with the dimmest brightness.
- Since **ECO MODE 1** and **ECO MODE 2** reduce the power consumption, the speakers are switched in function of the number of input channels. Because of this, a speaker switching sound (clicking sound) may be produced when the number of input channels is switched. If this bothers you, switch to a different listening mode.
- When using headphones, **SOUND RETRIEVER AIR** (only with the **ADAPTER PORT** input), **PHONES SURR**, **ECO MODE 1** and **ECO MODE 2** can be selected.

## Using Stream Direct

Use the Stream Direct modes when you want to hear the truest possible reproduction of a source. All unnecessary signal processing is bypassed, and you're left with the pure analog or digital sound source. Processing differs depending on the input signal and whether or not surround back speakers are connected. For details, see [Auto Surround, ALC and Stream Direct with different input signal formats](#) on [page 111](#).

- **While listening to a source, press AUTO (AUTO SURR/ALC/STREAM DIRECT) to select the mode you want.**

Check the digital format indicators in the front panel display to see how the source is being processed.

- **AUTO SURROUND** – See [Auto playback](#) on [page 52](#).
- **ALC** – Listening in Auto level control mode ([page 52](#)).  
—When **ALC** is selected, the effect level can be adjusted using the **EFFECT** parameter in [Setting the Audio options](#) on [page 67](#).
- **DIRECT** – Plays back sound from the source with the least modification next to **PURE DIRECT**. With **DIRECT**, the only modifications added to **PURE DIRECT** playback are calibration of the sound field by the MCACC system and the Phase Control effect.
- **PURE DIRECT** – Plays back unmodified sound from source with only minimal digital treatment.



### Note

When listening through headphones, you can select **ALC** or **PURE DIRECT** mode only.



## Selecting MCACC presets

- Default setting: **MEMORY 1**

If you have calibrated your system for different listening positions, you can switch between settings to suit the kind of source you're listening to and where you're sitting (for example, watching movies from a sofa, or playing a video game close to the TV).

- 1 Press **MAIN RECEIVER** to the receiver operation mode, then press **AUDIO P.**
- 2 Use **↑/↓** to select 'MCACC'.
- 3 Use **←/→** to select the setting.

Press repeatedly to select one of the six MCACC presets. See [Data Management](#) on [page 87](#) to check and manage your current settings.

- These settings have no effect when headphones are connected.
- You can also press **←/→** to select the MCACC preset.

## Choosing the input signal

On this receiver, it is possible to switch the input signals for the different inputs as described below.

- This receiver can only play back Dolby Digital, PCM (32 kHz to 192 kHz) and DTS (including DTS 96/24) digital signal formats. The compatible signals via the HDMI terminals are: Dolby Digital, DTS, PCM (32 kHz to 192 kHz), Dolby TrueHD, Dolby Digital Plus, DTS-EXPRESS, DTS-HD Master Audio and SACD.
- You may get digital noise when an LD, CD, DVD or BD player compatible with DTS is playing an analog signal. To prevent noise, make the proper digital connections ([page 23](#)) and set the signal input to **DIGITAL**.
- Some DVD players don't output DTS signals. For more details, refer to the instruction manual supplied with your DVD player.

- 1 Press **MAIN RECEIVER** to the receiver operation mode, then press **AUDIO P.**
- 2 Use **↑/↓** to select 'SIGSEL'.
- 3 Use **←/→** to select the input signal corresponding to the source component.

Each press cycles through the options as follows:

- **AUTO** – The receiver selects the first available signal in the following order: **HDMI**; **DIGITAL**; **ANALOG**.
- **ANALOG** – Selects an analog signal.
- **DIGITAL** – Select an optical or coaxial digital input signal. 'DIGITL' is displayed on the front panel display.
- **HDMI** – Selects an HDMI signal.
  - When the **HDMI** audio output parameter is set to **THROUGH**, the sound will be heard through your TV, not from this receiver.

When set to **DIGITAL**, **HDMI** or **AUTO** (only selected **DIGITAL** or **HDMI**), the indicators light according to the signal being decoded (see [Display](#) on [page 15](#)).

## Better sound using Phase Control

This receiver's Phase Control feature uses phase correction measures to make sure your sound source arrives at the listening position in phase, preventing unwanted distortion and/or coloring of the sound.

Phase Control technology provides coherent sound reproduction through the use of phase matching for an optimal sound image. The default setting is on and we recommend leaving Phase Control switched on for all sound sources.

- 1 Press **MAIN RECEIVER** to the receiver operation mode, then press **AUDIO P.**
- 2 Use **↑/↓** to select 'PHASE'.
- 3 Use **←/→** to switch on phase correction.

The **PHASE CONTROL** indicator on the front panel lights.

### Notes

- Phase matching is a very important factor in achieving proper sound reproduction. If two waveforms are 'in phase', they crest and trough together, resulting in increased amplitude, clarity and presence of the sound signal. If a crest of a wave meets a trough, then the sound will be 'out of phase' and an unreliable sound image will be produced.
- For discs created with standards other than Phase Control, the LFE channel is delayed upon recording in the first place. Phase Control Plus function corrects for phase shifting on such discs. For instructions on setting the Phase Control Plus, see [Setting the Audio options](#) on [page 67](#).
- If your subwoofer has a phase control switch, set it to the plus (+) sign (or 0°). However, the effect you can actually feel when **PHASE CONTROL** is set to **ON** on this receiver depends on the type of your subwoofer. Set your subwoofer to maximize the effect. It is also recommended you try changing the orientation or the place of your subwoofer.
- Set the built-in lowpass filter switch of your subwoofer to off. If this cannot be done on your subwoofer, set the cutoff frequency to a higher value.
- If the speaker distance is not properly set, you may not have a maximized **PHASE CONTROL** effect.
- The **PHASE CONTROL** mode cannot be set to **ON** in the following cases:
  - When headphones are plugged in.
  - When the **PURE DIRECT** mode is switched on.
  - When the **HDMI** audio output parameter is set to **THROUGH** in Setting the [Setting the Audio options](#) on [page 67](#).





## Playback with NETWORK features

Introduction .....	56
Playback with Network functions.....	57
About network playback .....	60
About playable file formats.....	61



## Introduction

This receiver is equipped with the LAN terminal and you can enjoy the following features by connecting your components to these terminals.

### Listening to Internet radio stations

You can select and listen to your favorite Internet radio station from the list of Internet radio stations created, edited, and managed by the vTuner database service exclusively for use with the Pioneer products.

→ See [Playback with Network functions](#) on [page 57](#) and [Listening to Internet radio stations](#) on [page 57](#).

### Playback the music files stored in PCs

You can playback a lot of musics stored in your PCs using this unit.

- Besides a PC, you can also play back audio files stored on your other components with the built-in media server function based on DLNA 1.0 or DLNA 1.5 framework and protocols (i.e. network-capable hard disks and audio systems).

→ See [Playback with Network functions](#) on [page 57](#) and [Playing back audio files stored on components on the network](#) on [page 59](#).

### Listening to Pandora Internet Radio

→ See [Listening to Pandora Internet Radio](#) on [page 58](#).

### Listening to Spotify audio streaming playback

→ See [About the Spotify audio stream playback function](#) on [page 59](#).



#### Notes

- To listen to Internet radio stations, you must sign a contract with an ISP (Internet Service Provider) beforehand.
- Photo or video files cannot be played back.
- With Windows Media Player 11 or Windows Media Player 12, DRM-protected audio files cannot be played back on this receiver.

## About playable DLNA network devices

This unit allows you to play music on media servers connected on an identical Local Area Network (LAN) as the receiver. This unit allows for the playing of files stored on the following devices:

- PCs running Microsoft Windows Vista or XP with Windows Media Player 11 installed
- PCs running Microsoft Windows 7 or Windows 8 with Windows Media Player 12 installed
- DLNA-compatible digital media servers (on PCs or other components)

Files stored in a PC or DMS (Digital Media Server) as described above can be played via command from an external Digital Media Controller (DMC). Devices controlled by this DMC to play files are called DMRs (Digital Media Renderers). This receiver supports this DMR function. When in the DMR mode, such operations as playing and stopping files can be performed from the external controller. Volume adjustment and the muting control are also possible. The DMR mode is canceled if the remote control unit is operated while in the DMR mode (aside from certain buttons, including the **VOLUME +/-**, **MUTE** and **DISP**).

- Depending on the external controller being used, playback may be interrupted when the volume is adjusted from the controller. In this case, adjust the volume from the receiver or remote control.

## Using AirPlay on iPod touch, iPhone, iPad, and iTunes

AirPlay works with iPhone, iPad, and iPod touch with iOS 4.3.3 or later, Mac with OS X Mountain Lion, and Mac and PC with iTunes 10.2.2 or later.

To use AirPlay, select your receiver on your iPod touch, iPhone, iPad or in iTunes. \*1

The receiver's input will switch automatically to AirPlay when AirPlay is in use. \*2

The following operations can be performed when in AirPlay mode:

- Adjustment of the receiver's volume from iPod touch, iPhone, iPad or iTunes.
- Pause/resume, next/previous track, and shuffle/repeat from the remote control of the receiver. \*3
- Display of the currently playing track information on the receiver's display, including artist, song and album name.

\*1: For more information, see the Apple website (<http://www.apple.com>).

\*2: The receiver's power automatically turns on when **Network Standby** at **Network Setup** is set to **ON**.

\*3: If operation is not possible, press **NET**, then operate again.



#### Notes

- A network environment is required to use AirPlay.
- The receiver's name that shows up in the AirPlay UI on iPod touch, iPhone, iPad and iTunes can be changed by **Friendly Name** from **Network Setup**.
- AirPlay provided on this receiver has been developed and tested based on the software versions for the iPod, iPhone, iPad and the software versions for iTunes that are indicated on the Pioneer website. AirPlay may not be compatible with iPod, iPhone, iPad or iTunes software versions other than those indicated on the Pioneer website.  
<http://pioneer.jp/homeav/support/ios/na/>

## About the DHCP server function

To play back audio files stored on components on the network or listen to Internet radio stations, you must turn on the DHCP server function of your router. In case your router does not have the built-in DHCP server function, it is necessary to set up the network manually. Otherwise, you cannot play back audio files stored on components on the network or listen to Internet radio stations. See [Network Setup menu](#) on [page 91](#) for more on this.

## Authorizing this receiver

This receiver must be authorized to enable playback. This happens automatically when the receiver makes a connection over the network to the PC. If not, please authorize this receiver manually on the PC. The authorization (or permission) method for access varies depending on the type of server currently being connected. For more information on authorizing this receiver, refer to the instruction manual of your server.





## About HTC Connect

This receiver features "HTC Connect", a simple way to enjoy music content from your HTC Connect certified smart phone.

- 1 HTC Connect music streaming provided on this product has been developed based on interoperability testing as defined by the HTC Connect Certification program with the HTC Connect-compatible smartphones.
- 2 Music Navigation via the music progress bar is not currently supported with HTC Connect.
- 3 Third party music applications (those other than HTC's pre-installed "Music" app) have not been tested for compatibility and may not work. HTC Connect has been tested with MP3, AAC, WMA and WAV encoding formats. Other formats may not be compatible.
- 4 High network congestion may interfere with the operation of HTC Connect.

## HTC Connect Certified Smartphones

The HTC Connect-compatible smartphones, Please check Pioneer website for up to date information about compatible devices and audio format support.

<http://www.pioneerelectronics.com/htc> (for USA)

<http://www.pioneerelectronics.ca/htc> (for Canada)



### Notes

- Specifications and design subject to modification without notice.
- HTC, HTC Connect and the HTC Connect logo are trademarks of HTC Corporation.

## Playback with Network functions



### Important

- About one minute is required between turning the power on and completion of startup.
- When you play back audio files, 'Connecting...' is displayed before playback starts. The display may continue for several seconds depending on the type of file.
- In case a domain is configured in a Windows network environment, you cannot access a PC on the network while you are logged onto the domain. Instead of logging onto the domain, log onto the local machine.
- There are cases where the time elapsed may not be correctly displayed.

### 1 Press NET repeatedly to select the category you want to play back.

It may take several seconds for this receiver to access the network.

Select a category from the following list:

- **INTERNET RADIO** – Internet radio
  - When **INTERNET RADIO** is selected, the radio station that was playing last time is played.
- **PANDORA** – Internet radio that supports Pandora
- **MEDIA SERVER** – Server components on the network
- **FAVORITES** – Favorite songs currently being registered

Depending on the selected category, the names of folders, files, and Internet radio stations are displayed.

### 2 Use ↑/↓ to select the folder, music files or Internet radio station to play back, and then press ENTER.

Press ↑/↓ to scroll up and down the list and select the desired item. When you press **ENTER**, playback starts with the playback screen being displayed for the selected item. To return to the list screen, press **RETURN**.

When the list screen is displayed from the playback screen, the playback screen reappears automatically if no operation is performed for three minutes while the list screen is displayed.

Only audio files with the 🎵 mark can be played. In case of the folders with the □ mark, use ↑/↓ and **ENTER** to select the desired folder and audio files.

- When ⏪ or ⏩ is pressed at the list screen, the page switches.
- To return to the playback screen from the list display, press **DISP**.

### 3 Repeat step 2 to play back the desired song.

For detailed operating instructions, refer to the section shown below.

- Internet radio stations – See [Listening to Internet radio stations on page 57](#).
- Pandora – See [Listening to Pandora Internet Radio on page 58](#).
- Media server – See [Playing back audio files stored on components on the network on page 59](#).
- Favorites – See [Playing back your favorite songs on page 59](#).

## Basic playback controls

You can perform the following operations with the remote control of this receiver. Note that some buttons are not available for operation depending on the category currently being played back.

- Press **NET** to switch the remote control to the network operation mode.

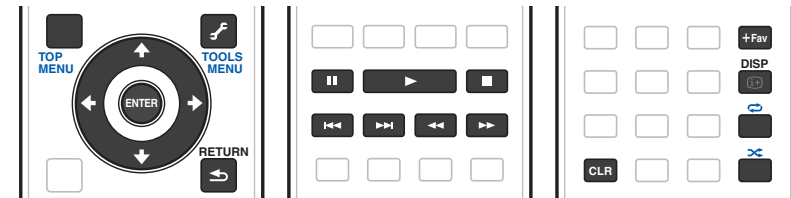

### Notes

- While a DSD file is being played, ⏪ and ⏩ are disabled.
- When input is **MEDIA SERVER** or **FAVORITES**, the following action is taken, depending on the server or file.
  - **||** may not work.
  - ⏪ and ⏩ may not work or may take the same action as ⏪ and ⏩.
- When input is **MEDIA SERVER**, by pressing **TOOLS** on the list display screen, you can switch the displayed titles in alphabetical order or track order.

## Listening to Internet radio stations

Internet radio is an audio broadcasting service transmitted via the Internet. There are a large number of Internet radio stations broadcasting a variety of services from every corner of the world. Some are hosted, managed, and broadcast by private individuals while others are by the corresponding traditional terrestrial radio stations or radio networks. Whereas terrestrial, or OTA (over-the-air), radio stations are geographically restricted on the range of radio waves broadcast from a transmitter through the air, Internet radio stations are accessible from anywhere in the world, as long as there is a connection to the Internet, as services are not transmitted through the air but are delivered over the World Wide Web. On this receiver you can select Internet radio stations by genre as well as by region.

Depending on the Internet line conditions, the sound may not be smooth when playing Internet radio.



### About list of Internet radio

The list of Internet radio stations on this receiver is created, edited, and managed by the vTuner database service exclusively for use with this receiver. For details about vTuner, see [vTuner](#) on [page 114](#).

### Saving and retrieving Internet radio stations

You can easily save and retrieve saved Internet radio stations. See [Playing back your favorite songs](#) on [page 59](#) for more on this.

- To listen to Internet radio stations, you must have high-speed broadband Internet access. With a 56 K or ISDN modem, you may not enjoy the full benefits of Internet radio.
- The port number varies depending on the Internet radio station. Check the firewall settings.
- A list of Internet radio stations provided by the vTuner database service is subject to change or deletion without notice due to various reasons.
- Broadcasts may be stopped or interrupted depending on the Internet radio station. In this case, you cannot listen to a radio station selected from the list of Internet radio stations.

### Registering broadcast stations not on the vTuner list from the special Pioneer site

With the receiver, broadcast stations not included on the list of station distributed by vTuner can be registered and played. Check the access code required for registration on the receiver, use this access code to access the special Pioneer Internet radio site and register the desired broadcast stations in your favorites. The address of the special Pioneer Internet radio site is:  
<http://www.radio-pioneer.com>

#### 1 Display the Internet Radio list screen.

To display the Internet Radio list screen, perform step 1 at [Playback with Network functions](#) on [page 57](#).

#### 2 Use **↑/↓** to select 'Help', then press ENTER.

#### 3 Use **↑/↓** to select 'Get access code', then press ENTER.

The access code required for registration on the special Pioneer Internet radio site is displayed. Make a memo of this address.

The following can be checked on the **Help** screen:

- **Get access code** – The access code required for registration on the special Pioneer Internet radio site is displayed.
- **Show Your WebID/PW** – After registering on the special Pioneer Internet radio site, the registered ID and password are displayed.
- **Reset Your WebID/PW** – Resets all the information registered on the special Pioneer Internet radio site. When reset, all the registered broadcast stations are also cleared. If you want to listen to the same stations, re-register after resetting.

#### 4 Access the special Pioneer Internet radio site from your computer and perform the registration process.

<http://www.radio-pioneer.com>

Access the above site and use the access code in step 3 to perform user registration, following the instructions on the screen.

#### 5 Register the desired broadcast stations as your favorites, following the instructions on the computer's screen.

Both broadcast stations not on the vTuner list and stations on the vTuner list can be registered. In this case they are registered on the receiver as favorite broadcast stations and can be played.

### Listening to Pandora Internet Radio

Pandora is personalized internet radio that is designed to help you discover new music you'll love mixed in with music you already know.

For details, check the website: <http://www.pandora.com>

- You must have a registered account in order to listen to songs using Pandora Internet Radio. Select **PANDORA**, then follow the instructions on the screen to make the account settings.
- See the Pandora website for regions in which the Pandora service is offered.
- Some functions may be changed at Pandora's discretion.



#### Notes

- When disposing of the product, we recommend you reset it to delete the data. See [Resetting the system](#) on [page 74](#).
- *Pandora®*, the leading internet radio service, gives people music they love anytime, anywhere, through personalized radio stations.

### Inputting characters using the software keyboard

#### 1 Press **TOOLS** to the software keyboard operation mode.

#### 2 Use **↑/↓/←/→** to select letters or symbols, then press **ENTER**.

Repeat this until all the desired characters have been input.

#### 3 Select '**OK**' on the software keyboard, then press **ENTER**.

- To quit inputting characters using the software keyboard, press the **TOOLS** button.



## About the Spotify audio stream playback function

Spotify is a music streaming distribution service managed and operated by Spotify Ltd. and distributing music over the Internet.

Spotify audio streams can be enjoyed using this unit and your smartphone or other mobile device.

### Preparations (1) Installing the Spotify application on mobile devices and registering a Spotify Premium account



#### Important

- The Spotify application must be installed on mobile devices and you must have registered a Spotify Premium account (for a charge) in order to use the Spotify audio stream playback function on this unit. For registration procedures and other Spotify services, see the Spotify website.  
<http://www.spotify.com/>
- For information on the countries and regions where Spotify services can be used, see the website below.  
<http://www.spotify.com/>

Spotify functions may be changed without notice.

An Internet connection is required on the mobile device in order to use the Spotify application. Using the mobile telephone line for the Internet connection tends to lead to high packet communication charges, so we recommend subscribing to a fixed packet rate plan. For details, contact your mobile telephone operator.

### Preparations (2) Connecting this unit to the network

- Connect this unit to the network and also to the Internet ([page 32](#)).
- Connect the mobile device by Wi-Fi to the wireless LAN router of the same network as the one to which this unit is connected. For instructions on connecting, see the operating instructions of the mobile device and the wireless LAN router.

## In order to use the Spotify audio stream playback function from the Spotify application

To use the Spotify audio stream playback function, select this unit on the Spotify application. When Spotify audio streaming starts, this unit's input automatically switches to Spotify.



#### CAUTION

Even if you are away from home, if you start Spotify audio streaming to play music on your mobile device and this unit is selected, the sound will be output from this unit. Depending on the volume level, the output may be loud, so be sure to check the audio output selection carefully before starting audio streaming. In addition, if you accidentally select this unit and play the sound on it, switch the audio output selection to the mobile device.



#### Notes

- A separate contract with/payment to an Internet service provider is required to use the Spotify audio stream playback function.
- This unit's name is displayed as the playback device on the Spotify application. Also, this unit's name can be changed at **Friendly Name** in the network settings.
- When this unit is selected with the Spotify application, the account information is registered on this unit as well. When disposing of this unit, reset this unit's settings in order to delete the account information registered on this unit. For instructions on resetting, see this unit's operating instructions.

## Playing back audio files stored on components on the network

This unit allows you to play music on media servers connected on an identical Local Area Network (LAN) as the receiver. This unit allows for the playing of files stored on the following devices:

- PCs running Microsoft Windows Vista or XP with Windows Media Player 11 installed
- PCs running Microsoft Windows 7 or Windows 8 with Windows Media Player 12 installed
- DLNA-compatible digital media servers (on PCs or other components)

## Playing back your favorite songs

Up to 64 favorite tracks on the media server and/or Internet radio stations can be registered in the Favorites folder. Note that only the audio files stored on components on the network can be registered.

## Registering and deleting audio files and Internet radio stations in and from the Favorites folder

- 1 Press **NET** repeatedly to select the **INTERNET RADIO** or **MEDIA SERVER**.
- 2 With the track or Internet radio station you want to register selected, press **+Favorite**.

The selected song or Internet radio station is then registered in the Favorite.



#### Note

To delete tracks or Internet radio stations that have been registered, set the input to **FAVORITES**, select the track or station to be deleted, then press the **CLR** button.



## About network playback

The network playback function of this unit uses the following technologies:

### Windows Media Player

See [Windows Media Player 11/Windows Media Player 12](#) on [page 115](#) for more on this.

### DLNA



#### DLNA CERTIFIED™ Audio Player

The Digital Living Network Alliance (DLNA) is a cross-industry organization of consumer electronics, computing industry and mobile device companies. Digital Living provides consumers with easy sharing of digital media through a wired or wireless network in the home.

The DLNA certification logo makes it easy to find products that comply with the DLNA Interoperability Guidelines. This unit complies with DLNA Interoperability Guidelines v1.5.

When a PC running DLNA server software or other DLNA compatible device is connected to this player, some setting changes of software or other devices may be required. Please refer to the operating instructions for the software or device for more information.

*DLNA™, the DLNA Logo and DLNA CERTIFIED™ are trademarks, service marks, or certification marks of the Digital Living Network Alliance.*

### Content playable over a network

- Even when encoded in a compatible format, some files may not play correctly.
- Movie or Photo files cannot be played back.
- There are cases where you cannot listen to an Internet radio station even if the station can be selected from a list of radio stations.
- Some functions may not be supported depending on the server type or version used.
- Supported file formats vary by server. As such, files not supported by your server are not displayed on this unit. For more information check with the manufacturer of your server.

### Disclaimer for Third Party Content

ACCESS TO THIRD PARTY CONTENT SERVICES, INCLUDING ALL ASSOCIATED FEATURES AND FUNCTIONALITIES, IS PROVIDED "AS IS," "AS AVAILABLE" AND AT THE USER'S OWN RISK, WITHOUT WARRANTY OF ANY KIND. PIONEER DISCLAIMS ALL WARRANTIES, EXPRESS OR IMPLIED, IN CONNECTION WITH ACCESS TO AND USE OF CONTENT SERVICES THROUGH THIS DEVICE, INCLUDING WITHOUT LIMITATION WARRANTIES OF MERCHANTABILITY, SATISFACTORY QUALITY, FITNESS FOR A PARTICULAR PURPOSE, AND NON-INFRINGEMENT. PIONEER DOES NOT GUARANTEE, REPRESENT, OR WARRANT THAT CONTENT SERVICES WILL BE FREE FROM ERRORS, INTERRUPTION, LOSS, CORRUPTION, ATTACK, VIRUSES, INTERFERENCE, HACKING, OR OTHER SECURITY INTRUSION, AND PIONEER DISCLAIMS ANY LIABILITY IN CONNECTION WITH THE FOREGOING. PIONEER IS NOT LIABLE OR RESPONSIBLE FOR ANY LOSS OR DAMAGE ARISING FROM ACCESS TO OR USE OF CONTENT. NO ORAL OR WRITTEN INFORMATION OR ADVICE GIVEN BY PIONEER OR ITS CUSTOMER SERVICES REPRESENTATIVES WILL CREATE ANY SUCH WARRANTY.

IN NO EVENT WILL PIONEER, ITS AFFILIATES, OR THEIR RESPECTIVE OFFICERS, DIRECTORS, OR EMPLOYEES BE LIABLE IN CONNECTION WITH YOUR USE OF THIRD PARTY CONTENT SERVICES THROUGH THIS DEVICE FOR PERSONAL INJURY OR SPECIAL, INCIDENTAL, INDIRECT OR CONSEQUENTIAL DAMAGES OF ANY KIND, INCLUDING WITHOUT LIMITATION DAMAGES FOR ATTORNEY'S FEES, LOST DATA OR LOST PROFITS, REGARDLESS OF THE THEORY OF LIABILITY AND WHETHER OR NOT ADVISED OF THE POSSIBILITY OF SUCH DAMAGES. IN NO EVENT WILL PIONEER'S TOTAL LIABILITY TO YOU FOR ALL DAMAGES ARISING FROM THE USE OR INABILITY TO USE THIRD PARTY CONTENT SERVICES (OTHER THAN AS MAY BE REQUIRED BY LAW IN CASES INVOLVING PERSONAL INJURY) EXCEED \$10.00. THE FOREGOING LIMITATIONS WILL APPLY EVEN IF THE ABOVE REMEDY FAILS OF ITS ESSENTIAL PURPOSE. IF ANY APPLICABLE AUTHORITY HOLDS ANY PORTION OF THIS SECTION TO BE UNENFORCEABLE, THEN LIABILITY WILL BE LIMITED TO THE MAXIMUM EXTENT PERMITTED BY APPLICABLE LAW.

### About playback behavior over a network

- Playback may stall when the PC is switched off or any media files stored on it are deleted while playing content.
- If there are problems within the network environment (heavy network traffic, etc.) content may not be displayed or played properly (playback may be interrupted or stalled). For best performance, a 100BASE-TX connection between player and PC is recommended.
- If several clients are playing simultaneously, as the case may be, playback is interrupted or stalled.
- Depending on the security software installed on a connected PC and the setting of such software, network connection may be blocked.

Pioneer is not responsible for any malfunction of the player and/or the NETWORK features due to communication error/malfunctions associated with your network connection and/or your PC, or other connected equipment. Please contact your PC manufacturer or Internet service provider.

*This product includes technology owned by Microsoft Corporation and cannot be used or distributed without a license from Microsoft Licensing, Inc.*

*Microsoft, Windows, Windows Media and Windows Vista are either registered trademarks or trademarks of Microsoft Corporation in the United States and/or other countries.*



### About playable file formats

The NETWORK feature of this receiver supports the following file formats. Note that some file formats are not available for playback although they are listed as playable file formats. Also, the compatibility of file formats varies depending on the type of server. Check with your server to ensure the compatibility of file formats supported by your server.

- Internet radio playback may be affected by the Internet communications environment, and in this case playback may not be possible even with the file formats listed here.
- With MP3, WAV, AAC, FLAC, AIFF and Apple Lossless files, when music files with the same format, sampling frequency, quantization bit number and number of channels are played successively, they are played with no gap.
  - Gapless playback is not possible when the format is being converted (transcoded) by the server.
  - Gapless playback is not possible in the DMR mode.
  - When AAC or MP3 format is used, sound is reproduced with the minimum gap. If you are conscious about gaps, use WAV or FLAC files.

### Music files

Category	Extension	Stream		
MP3 <a>	.mp3	MPEG-1 Audio Layer-3	Sampling frequency	32 kHz, 44.1 kHz, 48 kHz
			Quantization bitrate	16 bit
			Channel	2 ch
			Bitrate	8 kbps to 320 kbps
			VBR/CBR	Supported/Supported
WAV	.wav	LPCM	Sampling frequency <b>	32 kHz, 44.1 kHz, 48 kHz, 88.2 kHz, 96 kHz, 176.4 kHz, 192 kHz
			Quantization bitrate	16 bit, 24 bit
			Channel <c>	2 ch, 5.0 ch, 5.1 ch
WMA	.wma	WMA2/7/8/9 <d>	Sampling frequency	32 kHz, 44.1 kHz, 48 kHz
			Quantization bitrate	16 bit
			Channel	2 ch
			Bitrate	5 kbps to 320 kbps
			VBR/CBR	Supported/Supported
AAC	.m4a .aac .3gp .3g2	MPEG-4 AAC LC MPEG-4 HE AAC	Sampling frequency	32 kHz, 44.1 kHz, 48 kHz
			Quantization bitrate	16 bit
			Channel	2 ch
			Bitrate	16 kbps to 320 kbps
			VBR/CBR	Supported/Supported
Apple Lossless	.m4a .mp4	Apple Lossless	Sampling frequency	32 kHz, 44.1 kHz, 48 kHz, 88.2 kHz, 96 kHz
			Quantization bitrate	16 bit, 24 bit
			Channel	2 ch

Category	Extension	Stream		
FLAC <e>	.flac	FLAC	Sampling frequency <b>	32 kHz, 44.1 kHz, 48 kHz, 88.2 kHz, 96 kHz, 176.4 kHz, 192 kHz
			Quantization bitrate	16 bit, 24 bit
			Channel <c>	2 ch, 5.0 ch, 5.1 ch
AIFF	.aiff .aif	.aiff .aif	Sampling frequency	32 kHz, 44.1 kHz, 48 kHz, 88.2 kHz, 96 kHz, 176.4 kHz, 192 kHz
			Quantization bitrate	16 bit, 24 bit
			Channel	2 ch
DSD <f>	.dff .dsf	DSDIFF DSF	Sampling frequency	2.8224 MHz
			Quantization bitrate	1 bit
			Channel	2 ch

- a "MPEG Layer-3 audio decoding technology licensed from Fraunhofer IIS and Thomson multimedia."
- b 176.4 kHz and 192 kHz support 2-channel audio sources only.
- c
  - When playing the 5.0 channel or 5.1 channel file in the sub zone, only the front left and right sound is played. Multichannel playback is only available with the main zone.
  - Gapless playback is not possible with a 5.0-channel or 5.1-channel audio source.
- d Files encoded using Windows Media Codec 9 may be playable but some parts of the specification are not supported; specifically, Pro, Lossless, Voice.
- e Uncompressed FLAC files are not supported. Pioneer does not guarantee playback.
- f DSD files cannot be played in the sub zone.



## Control with HDMI function

About the Control with HDMI function .....	63
Making Control with HDMI connections .....	63
HDMI Setup .....	63
Before using synchronization.....	64
About synchronized operations.....	64
Setting the PQLS function.....	64
About Sound Retriever Link and Stream Smoother Link .....	64
Cautions on the Control with HDMI function .....	65



## About the Control with HDMI function

Synchronized operations below with a **Control** with HDMI-compatible Pioneer TV or Blu-ray Disc player are possible when the component is connected to the receiver using an HDMI cable.

- The receiver's volume can be set and the sound can be muted using the TV's remote control.
- The receiver's input switches over automatically when the TV's input is changed or a **Control** with HDMI-compatible component is played.
- The receiver's power is also set to standby, when the TV's power is set to standby.



### Important

- With Pioneer devices, the **Control** with HDMI functions are referred to as "KURO LINK".
- You cannot use this function with components that do not support **Control** with HDMI.
- We only guarantee this receiver will work with Pioneer **Control** with HDMI-compatible components. However, we do not guarantee that all synchronized operations will work with components that support the **Control** with HDMI function.
- Use a High Speed HDMI®/™ cable when you want to use the **Control** with HDMI function. The **Control** with HDMI function may not work properly if a different type of HDMI cable is used.
- For details about concrete operations, settings, etc., refer to also the operating instructions for each component.

## Making Control with HDMI connections

You can use synchronized operation for a connected TV and other components.

- Be sure to connect the TV's audio cable to the audio input of this unit. When the TV and receiver are connected by HDMI connections, if the TV supports the HDMI ARC (Audio Return Channel) function, the sound of the TV is input to the receiver via the **HDMI OUT 1** terminal, so there is no need to connect an audio cable. In this case, set **ARC** at **HDMI Setup** to **ON** (see [HDMI Setup](#) on [page 63](#)).

For details, see [Connecting your TV and playback components](#) on [page 25](#).



### Important

- When connecting this system or changing connections, be sure to switch the power off and disconnect the power cord from the wall socket. After completing all connections, connect the power cords to the wall socket.
- After this receiver is connected to an AC outlet, a 2 second to 10 second HDMI initialization process begins. You cannot carry out any operations during this process. The **HDMI** indicator in the front panel display blinks during this process, and you can turn on this receiver once it has stopped blinking. When you set the **Control** with HDMI to **OFF**, you can skip this process. For details about the **Control** with HDMI feature, see [Control with HDMI function](#) on [page 62](#).
- To get the most out of this function, we recommend that you connect your HDMI component not to a TV but rather directly to the HDMI terminal on this receiver.
- The **Control** with HDMI function can be used with a TV connected to the **HDMI OUT 1** terminal, but not with a TV connected to the **HDMI OUT 2** terminal.

## HDMI Setup

You must adjust the settings of this receiver as well as the connected **Control** with HDMI-compatible components in order to make use of the **Control** with HDMI function. For more information see the operating instructions for each component.

- 1 Press **MAIN RECEIVER** to the receiver operation mode, then press **HOME MENU**.

- 2 Select '**System Setup**', then press **ENTER**.

- 3 Select '**HDMI Setup**', then press **ENTER**.

- 4 Select the '**Control**' setting you want.

Choose whether to set this unit's **Control** with HDMI function **ON** or **OFF**. You will need to set it to **ON** to use the **Control** with HDMI function.

When using a component that does not support the **Control** with HDMI function, set this to **OFF**.

- **ON** – Enables the **Control** with HDMI function. Set **Control Mode**, **ARC** and **PQLS** in the subsequent setting items to the desired values.

Also, by setting this to **ON**, the Sound Retriever Link and Stream Smoother Link functions can be operated automatically by connecting a player supporting the respective functions. See [Setting the Audio options](#) on [page 67](#) for details on Sound Retriever Link, [Setting the Video options](#) on [page 69](#) for details on Stream Smoother Link.

- **OFF** – The **Control** with HDMI is disabled. The **Control Mode**, **ARC** and **PQLS** functions in the subsequent setting items cannot be used.

- 5 Select the '**Control Mode**' setting you want.

Choose whether you want to enable synchronized operations.

- **ON** – Enabled for the synchronized operations.
- **OFF** – The synchronized operations disabled.

- 6 Select the '**ARC**' setting you want.

When a TV supporting the HDMI ARC (Audio Return Channel) function is connected to the receiver, the sound of the TV can be input via the **HDMI OUT 1** terminal.

After setting the **ARC**, some time may be required for the connected device to be recognized and the sound to be produced.

- **ON** – The TV's sound is input via the HDMI terminal.
- **OFF** – The TV's sound is input from the Audio input terminals other than HDMI inputs.

- 7 Select the '**PQLS**' setting you want.

Choose whether to set this unit's **PQLS** function **AUTO** or **OFF**.

For details about PQLS function, see [Setting the PQLS function](#) on [page 64](#).

- **AUTO** – PQLS is enabled. A precision quartz controller in this receiver eliminates distortion caused by timing errors (jitter), giving you the best possible digital-to-analog conversion when you use the HDMI interface. This is valid as an HDMI function for PQLS-compatible players.
- **OFF** – PQLS is disabled.

- 8 Select the '**Standby Through**' setting you want.

It is possible to transfer signals from an HDMI-connected player to the TV when this receiver's power is on standby.

Select the HDMI input whose HDMI signal is to be input for through transfer when in the standby mode. When **LAST** is selected, the signal being input to the currently selected HDMI input is transferred. When **OFF** is selected, no HDMI input is transferred through when in the standby mode. (However, when **Control** is set to **ON**, the HDMI signal is transferred through by the **Control** with HDMI function even when in the standby mode.)

- When anything other than **OFF** is set for this setting, the receiver's HDMI input can be switched even when the receiver is in the standby mode. (Switch by pointing the remote control at the receiver and pressing the **HDMI**, **BD**, **DVD** or **SAT/CBL** button.)
- Setting to anything other than **OFF** increases power consumption in the standby mode.
- This setting can be used even with devices that are not compatible with the **Control** with HDMI function.
- The Standby Through function cannot be used with MHL-compatible devices.

- 9 When you're finished, press **HOME MENU**.





## Before using synchronization

Once you have finished all connections and settings, you must:

- 1 Put all components into standby mode.
- 2 Turn the power on for all components, with the power for the TV being turned on last.
- 3 Choose the HDMI input to which the TV is connected to this receiver, and see if video output from connected components displays properly on the screen or not.
- 4 Check whether the components connected to all HDMI inputs are properly displayed.

## About synchronized operations



### Important

- Synchronized operations are enabled when **Control Mode** is set to **ON** after setting **Control** in **HDMI Setup** to **ON**. For details, see [HDMI Setup](#) on [page 63](#).
- The **Control** with HDMI-compatible component connected to the receiver operates in sync as described below.
- From the menu screen of the **Control** with HDMI-compatible TV, set audio to be played through this receiver, and the receiver will switch to the synchronized amp mode.
  - When in the synchronized amp mode, you can adjust the receiver's volume or mute the sound using the TV's remote control.
  - When in the synchronized amp mode, the synchronized amp mode is canceled when the receiver's power is turned off. To turn the synchronized amp mode back on, set audio to be played through the receiver from the TV's menu screen, etc. This receiver will power up and switch to the synchronized amp mode.
  - When the synchronized amp mode is canceled, the receiver's power turns off if you were viewing an HDMI input or a TV program on the TV.
  - When in the synchronized amp mode, the synchronized amp mode is canceled if an operation that produces sound from the TV is performed from the TV's menu screen, etc.
  - When the TV's power is set to standby, the receiver's power is also set to standby. (Only when the input for a component connected to the receiver by HDMI connection is selected or when watching the TV.)
  - The receiver's input switches automatically when the **Control** with HDMI-compatible component is played.
  - The receiver's input switches automatically when the TV's input is switched.
  - The synchronized amp mode remains in effect even if the receiver's input is switched to a component other than one connected by HDMI.

The operations below can also be used on Pioneer **Control** with HDMI-compatible TVs.

- When the receiver's volume is adjusted or the sound is muted, the volume status is displayed on the TV's screen.
- When the OSD language is switched on the TV, the receiver's language setting also switches accordingly.

## Setting the PQLS function

PQLS (Precision Quartz Lock System) is a digital audio signal transfer control technology using the **Control** with HDMI function. It offers higher-quality audio playback by controlling audio signals from the receiver to a PQLS compatible player, etc. This enables removing jitter that has a negative effect on the quality of the sound and is generated upon transmission.

- On players compatible with PQLS Bit-stream, PQLS always works for all sources.
- On players compatible with PQLS Multi Surround, PQLS works for all sources. Set the player's audio output to Linear PCM.
- On players compatible with PQLS 2 ch Audio, PQLS only works when playing CDs. Please refer to the operating instructions supplied with your player for more information. This function is activated when **Control** is set to **ON**.



### Tip

- The PQLS setting is set at **PQLS** in **HDMI Setup** on the **HOME MENU**, but the setting can also be switched with the remote control, as described below.

- 1 Press **MAIN RECEIVER** to the receiver operation mode, then press **AUDIO P..**
- 2 Use **↑/↓** to select '**PQLS**'.
- 3 Use **←/→** to select the **PQLS** setting.

The setting is displayed on the front panel display.

- **AUTO** – PQLS is enabled. A precision quartz controller in this receiver eliminates distortion caused by timing errors (jitter), giving you the best possible digital-to-analog conversion when you use the HDMI interface. This is valid as an HDMI function for PQLS-compatible players.
- **OFF** – PQLS is disabled.

## About Sound Retriever Link and Stream Smoother Link

These are automatic functions allowing you to output optimum audio and video signals from the receiver using the **Control** with HDMI function. When a player supporting the respective function is connected to the receiver by HDMI, the sound/picture is optimized for the compressed audio/video file played on the player.

- Depending on the compressed audio/video file format, it may not be operated automatically.
- Also see the player's operating instructions.

### Sound Retriever Link

When playing a compressed audio file on the player, the file's bitrate information is acquired using the **Control** with HDMI function, and the sound is optimized on the receiver based on this information.

To activate the Sound Retriever Link function, make the setting below.

- 1 Set the **HDMI Setup's Control** to **ON**, and set the **Control Mode** setting to **ON**.

See [HDMI Setup](#) on [page 63](#).

- 2 Set the **S.RTRV (Auto Sound Retriever)** setting to **ON**.

See [Setting the Audio options](#) on [page 67](#).





---

### Stream Smoother Link

Using the **Control** with HDMI function, the receiver automatically detects whether a compressed video file is being played on the player, and if so automatically activates the Stream Smoother function.

To activate the Stream Smoother Link function, make the setting below.

**1 Set the HDMI Setup's Control to ON, and set the Control Mode setting to ON.**

See [HDMI Setup](#) on [page 63](#).

**2 Set the STREAM (Stream Smoother) setting to AUTO.**

See [Setting the Video options](#) on [page 69](#).

---

### Cautions on the Control with HDMI function

- Connect the TV directly to this receiver. Interrupting a direct connection with other amps or an AV converter (such as an HDMI switch) can cause operational errors.
- Only connect components (Blu-ray Disc player, etc.) you intend to use as a source to the HDMI input of this receiver. Interrupting a direct connection with other amps or an AV converter (such as an HDMI switch) can cause operational errors.
- When the receiver's **Control** is turned **ON**, even if the receiver's power is in the standby mode, it is possible to output the audio and video signals from a player via HDMI to the TV without producing sound from the receiver, but only when a **Control** with HDMI-compatible component (Blu-ray Disc player, etc.) and compatible TV are connected. In this case, the receiver's power turns on and the power and **HDMI** indicators light.
- If the **Control** setting is not set to **OFF**, the power consumption during standby will increase.



## Using other functions

Setting the Audio options .....	67
Setting the Video options.....	69
Switching the output (OUTPUT PARAMETER) .....	71
Changing the channel level while listening .....	71
Using the MULTI-ZONE controls.....	72
Network settings from a web browser .....	73
Using the sleep timer .....	73
Dimming the display .....	73
Checking your system settings.....	73
Resetting the system.....	74



## Setting the Audio options

There are a number of additional sound settings you can make using the **AUDIO PARAMETER** menu. The defaults, if not stated, are listed in bold.



### Important

- Note that if a setting doesn't appear in the **AUDIO PARAMETER** menu, it is unavailable due to the current source, settings and status of the receiver.

**1 Press MAIN RECEIVER to the receiver operation mode, then press AUDIO P..**

**2 Use ↑/↓ to select the setting you want to adjust.**

Depending on the current status/mode of the receiver, certain options may not be able to be selected. Check the table below for notes on this.

**3 Use ←/→ to set as necessary.**

See the table below for the options available for each setting.

**4 Press RETURN to confirm and exit the menu.**

## Audio parameter menu

Setting	What it does	Option(s)
<b>MCACC</b> (MCACC preset)	Selects your favorite MCACC preset memory when multiple preset memories are saved. When an MCACC preset memory has been renamed, the given name is displayed.	◀ M1. MEMORY 1 to M6. MEMORY 6 ▶ Default: <b>M1. MEMORY 1</b>
<b>EQ</b> (Acoustic Calibration EQ)	Switches on/off the effects of EQ Pro.	<b>ON</b> OFF
<b>S-WAVE</b> (Standing Wave)	Switches on/off the effects of Standing Wave Control.	<b>ON</b> OFF
<b>PHASE</b> (Phase Control)	Switches on/off the effects of Phase Control (page 54).	<b>ON</b> OFF
<b>Phase C+</b> (Phase Control Plus)	For discs created with standards other than Phase Control, the LFE channel is delayed upon recording in the first place. This function corrects for phase shifting on such discs. This function is especially effective when playing music. When <b>AUTO</b> is selected, not only the low range delay but also the polarity and correlation are detected to achieve the optimum effect.	◀ AUTO/0 to 16 (ms) ▶ Default: <b>AUTO</b>
<b>DELAY</b> (Sound Delay)	Some monitors have a slight delay when showing video, so the soundtrack will be slightly out of sync with the picture. By adding a bit of delay, you can adjust the sound to match the presentation of the video.	◀ 0 to 800 (ms) ▶ Default: <b>0</b>
<b>TONE</b> (Tone Control)	Applies the treble and bass tone controls to a source, or bypasses them completely. This setting is only displayed when the listening mode is <b>STEREO</b> , Auto surround ( <b>STEREO</b> ) or <b>SOUND RETRIEVER AIR</b> .	<b>BYPASS</b> ON
<b>BASS</b> <a>	Adjusts the amount of bass.	◀ -6 to +6 (dB) ▶ Default: <b>0</b> (dB)
<b>TREBLE</b> <a>	Adjusts the amount of treble.	◀ -6 to +6 (dB) ▶ Default: <b>0</b> (dB)

Setting	What it does	Option(s)
<b>S.RTRV</b> (Auto Sound Retriever) <b>	With the Auto Sound Retriever function, DSP processing is used to compensate for the loss of audio data upon compression, improving the sound's sense of density and modulation. Also, when a player supporting the Sound Retriever Link function is connected to the receiver by HDMI, by setting this to <b>ON</b> , the bitrate information of the compressed audio file being played on the player is acquired using the <b>Control</b> with HDMI function, and the sound is optimized based on this information (Sound Retriever Link).	OFF ON
<b>DNR</b> (Digital Noise Reduction)	May improve the quality of sound in a noisy source (for example, video tape with lots of background noise) when switched on. This only has an effect with 2-channel signal inputs. This mode is effective for contents with a sampling frequency of 48 kHz or less.	<b>OFF</b> ON
<b>DIALOG E</b> (Dialog Enhancement) <c>	Localizes dialog in the center channel to make it stand out from other background sounds in a TV or movie soundtrack. By moving from UP1 through UP2 and UP3 up to UP4, you can make the sound source seem to relocate upwards.	◀ OFF/FLAT/UP1/UP2/UP3/UP4 ▶ Default: <b>OFF</b>
<b>Hi-bit24</b>	Creates a wider dynamic range with digital sources like CDs, DVDs or BDs. 16- and 20-bit PCM as well as compressed audio is requantized to 24 bits, more subtle musical expression. This mode is effective for contents with a sampling frequency of 48 kHz or less.	<b>ON</b> OFF
<b>PQLS</b> (Precision Quartz Lock System)	Switches the PQLS function between AUTO and OFF (Setting the PQLS function on page 64).	<b>AUTO</b> OFF
<b>DUAL</b> (Dual Mono)	Specifies how dual mono encoded Dolby Digital soundtracks should be played. Dual mono is not widely used, but is sometimes necessary when two languages need to be sent to separate channels.	<b>CH1</b> – Channel 1 is heard only <b>CH2</b> – Channel 2 is heard only <b>CH1 CH2</b> – Both channels heard from front speakers
<b>SIGSEL</b> (Signal Select)	Use to switch the input signal type (analog/digital/HDMI) (page 54).	<b>AUTO</b> ANALOG DIGITAL <d> HDMI
<b>Fixed PCM</b>	This is useful if you find there is a slight delay before <b>OFF</b> recognizes the PCM signal on a CD, for instance. When <b>ON</b> is selected, noise may be output during playback of non-PCM sources. Please select another input signal if this is a problem.	<b>OFF</b> ON
<b>DRC</b> (Dynamic Range Control) <e>	Adjusts the level of dynamic range for movie soundtracks optimized for Dolby Digital, DTS, Dolby Digital Plus, Dolby TrueHD, DTS-HD and DTS-HD Master Audio (you may need to use this feature when listening to surround sound at low volumes).	<b>AUTO</b> MAX MID OFF
<b>Loud Mgmt</b> (Loudness Management)	This is a setting of the post process function of the Dolby TrueHD decoder. By setting to OFF, you can enjoy higher sound quality. This can only be set when <b>DRC</b> is set to <b>OFF</b> and the input signal is a Dolby TrueHD signal.	<b>ON</b> OFF



Setting	What it does	Option(s)
<b>LFE</b> (LFE Attenuate)	Some audio sources include ultra-low bass tones. Set the LFE attenuator as necessary to prevent the ultra-low bass tones from distorting the sound from the speakers. When set to the recommended value of 0 dB, the LFE is not restricted. When set to a value other than 0 dB, the LFE is restricted to the set value. When OFF is selected, the sound is not output from the LFE channel.	◀ OFF/ -20dB/ -15dB/ -10dB/ -5dB/ -4dB/ -3dB/ -2dB/ -1dB/ 0dB ▶ Default: <b>0dB</b>
<b>INPUT ATT</b> (Input attenuate) <f>	If the sound is distorted, this can be used to lower the input signal level and reduce the distortion.	<b>OFF</b> ON
<b>HDMI</b> (HDMI Audio) <g>	Specifies the routing of the HDMI audio signal out of this receiver (amp) or through to a TV. When THROUGH is selected, no sound is output from this receiver.	<b>AMP</b> THROUGH
<b>A.DELAY</b> (Auto delay) <h>	This feature automatically corrects the audio-to-video delay between components connected with an HDMI cable. The audio delay time is set depending on the operational status of the display connected with an HDMI cable. The video delay time is automatically adjusted according to the audio delay time.	<b>OFF</b> ON
<b>C.WIDTH</b> (Center Width) (Applicable only when using a center speaker) <i>	Provides a better blend of the front speakers by spreading the center channel between the front right and left speakers, making it sound wider (higher settings) or narrower (lower settings).	◀ 0 to 7 ▶ Default: <b>3</b>
<b>DIMENSION</b> <i>	Adjusts the depth of the surround sound balance from front to back, making the sound more distant (minus settings), or more forward (positive settings).	◀ -3 to +3 ▶ Default: <b>0</b>
<b>PANORAMA</b> <i>	Extends the front stereo image to include the surround speakers for a 'wraparound' effect.	<b>OFF</b> ON
<b>C.GAIN</b> (Center Gain) (Applicable only when using a center speaker) <j>	Adjusts the center gain to create a wider stereo effect with vocals. Adjust the effect from 0 (all center channel sent to front right and left speakers) to 1.0 (center channel sent to the center speaker only).	◀ 0 to 1.0 ▶ Defaults: Neo:X CINEMA: <b>1.0</b> Neo:X MUSIC: <b>0.3</b> Neo:X GAME: <b>1.0</b>
<b>EFFECT</b>	Sets the effect level for the ALC mode.	◀ 10 to 90 ▶ Defaults: <b>50</b>
<b>H.GAIN</b> (Height Gain)	Adjusts the output from the front height speaker when listening in <b>XX Pro Logic IIz HEIGHT</b> mode. If set to HIGH, the sound from the top will be more emphasized.	LOW <b>MID</b> HIGH AUTO
<b>V.SP</b> (Virtual Speakers)	When <b>AUTO</b> is selected, the sound field is created with the surround back, front height and front wide channels whose <b>Speaker Setting</b> is set to <b>NO</b> automatically complemented. To set the respective channels individually, select <b>MANUAL</b> .	<b>MANUAL</b>
<b>V.SB</b> (Virtual Surround Back) <k>	When you're not using surround back speakers, selecting this mode allows you to hear a virtual surround back channel through your surround speakers. You can choose to listen to sources with no surround back channel information.	<b>OFF</b> ON
<b>V.HEIGHT</b> (Virtual Height) <l>	When you're not using front height speakers, selecting this mode allows you to hear a virtual front height channel through your front speakers.	<b>OFF</b> ON

Setting	What it does	Option(s)
<b>V.WIDE</b> (Virtual Wide) <m>	When you're not using front wide speakers, selecting this mode allows you to hear a virtual front wide channel through your front speakers. This improves the continuity of the sound from the front channel to the surround channels.	<b>OFF</b> ON
<b>V.DEPTH</b> (Virtual Depth) <n>	When this mode is selected, the sound field expands virtually to behind the display, resulting in a sound field with the same depth as the 3D picture to achieve a better sense of presence.	<b>OFF</b> MIN MID MAX

- a The adjustment can be made only when **TONE** is set to **ON**.
- b
- The default value changes depending on the type of input ([page 74](#)).
  - When **ON** is selected, the Sound Retriever effect is optimized based on the bitrate information of the contents input to the USB memory audio and **INTERNET RADIO, PANDORA, MEDIA SERVER, FAVORITES** (digital audio input only) to achieve high sound quality.
  - With the **iPod/USB, INTERNET RADIO, PANDORA, MEDIA SERVER, FAVORITES** or **ADAPTER PORT** input function, by default **S.RTRV** is set to **ON**.
  - When **ON** is selected, optimum correction of the audio signals input via the **HDMI OUT** terminal is conducted with the HDMI ARC (Audio Return Channel) function, and the sound of digital TV broadcasts is produced with HD quality. This is valid when the input is set to **TV** and **ARC** in **HDMI Setup** is set to **ON**. (See [HDMI Setup](#) on [page 63](#).)
- c UP1 to UP4 can be selected only when the front height speaker is connected. The presence or absence of effects depends on the listening mode.
- d On the front panel display, 'DIGITL' is displayed.
- e The initially set **AUTO** is only available for Dolby TrueHD signals. Select **MAX** or **MID** for signals other than Dolby TrueHD.
- f
- The attenuator isn't available when using the Stream Direct (ANALOG DIRECT) modes.
  - The attenuator does not function when the listening mode is set to **PURE DIRECT** with AirPlay.
- g
- The HDMI Audio setting cannot be switched while performing synchronized amp mode operations.
  - The synchronized amp mode must be turned on in order to play the receiver's HDMI audio and video input signals from the TV with the receiver's power in the standby mode. See [About synchronized operations](#) on [page 64](#).
- h This feature is only available when the connected display supports the automatic audio/video synchronizing capability ('lipsync') for HDMI. If you find the automatically set delay time unsuitable, set **A.DELAY** to **OFF** and adjust the delay time manually. For more details about the lipsync feature of your display, contact the manufacturer directly.
- i Only when listening to 2-channel sources in Dolby Pro Logic IIx Music/Dolby Pro Logic II Music mode.
- j Only when listening to 2-channel sources in Neo:X CINEMA/MUSIC/GAME mode.
- k
- This can be set when **MANUAL** is selected for **V.SP**s.
  - You can't use the Virtual Surround Back mode when the headphones are connected to this receiver or when any of the stereo, Front Stage Surround Advance, Sound Retriever Air or Stream Direct modes is selected.
  - You can only use the Virtual Surround Back mode if the surround speakers are on and the **SB** setting is set to **NO** or if **Front Bi-Amp, ZONE 2** or **HDZONE** is selected at **Speaker System**. It can also be used when **Speaker B** is selected at **Speaker System** and **SP:▶A+B ON** is selected with the **OUT P.** button.
  - This mode is effective for contents with a sampling frequency of 48 kHz or less.
- l
- This can be set when **MANUAL** is selected for **V.SP**s.
  - You can't use the Virtual Height mode when the headphones are connected to this receiver or when any of the stereo, Front Stage Surround Advance, Sound Retriever Air or Stream Direct modes is selected.
  - You can only use the Virtual Height mode if the surround speakers are on and the **FH** setting is set to **NO**. It can also not be used when playing signals containing actual front height channel information.
  - This mode is effective for contents with a sampling frequency of 48 kHz or less.
- m
- This can be set when **MANUAL** is selected for **V.SP**s.
  - You can't use the Virtual Wide mode when the headphones are connected to this receiver or when any of the stereo, Front Stage Surround Advance, Sound Retriever Air or Stream Direct modes is selected.
  - You can only use the Virtual Wide mode if the surround speakers are on and the **FW** setting is set to **NO**. It can also not be used when playing signals containing actual front wide channel information.
  - This mode is effective for contents with a sampling frequency of 48 kHz or less.
- n
- This mode is effective for contents with a sampling frequency of 48 kHz or less.
  - You can't use the Virtual Depth mode when the headphones are connected to this receiver or Stream Direct modes is selected.



## Setting the Video options

There are a number of additional picture settings you can make using the **VIDEO PARAMETER** menu. The defaults, if not stated, are listed in bold.



### Important

- When **MAIN/HDZONE** is set to **HDZONE**, the **VIDEO PARAMETER** menu setting only affects the **HDMI OUT 1** terminal signal.  
Also, when **HDZONE** is set to **ON**, **VIDEO PARAMETER** cannot be set (does not work).
- Note that if an option cannot be selected on the **VIDEO PARAMETER** menu, it is unavailable due to the current source, setting and status of the receiver.
- All of the setting items can be set for each input function.  
—However, with the audio only input function, **VIDEO PARAMETER** cannot be set.  
—Also, when **HDZONE** is set to **ON**, **VIDEO PARAMETER** cannot be set (does not work).
- Setting items other than **V.CONV** can only be selected when **V.CONV** is set to **ON**.

**1 Press MAIN RECEIVER to the receiver operation mode, then press VIDEO P..**

**2 Use ↑/↓ to select the setting you want to adjust.**

Depending on the current status/mode of the receiver, certain options may not be able to be selected. Check the table below for notes on this.



**3 Use ←/→ to set as necessary.**

See the table below for the options available for each setting.



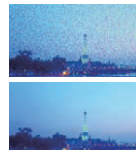

**4 Press RETURN to confirm and exit the menu.**

## Video parameter menu

Setting	What it does	Option(s)
<b>V.CONV</b> (Digital Video Converter) <a>	Converts video signals for output from the <b>HDMI OUT 1</b> terminal for all video types (see <a href="#">page 24</a> ).	ON <b>OFF</b>
<b>RES</b> (Resolution) <b>	Specifies the output resolution of the video signal (when video input signals are output at the <b>HDMI OUT</b> terminals, select this according to the resolution of your monitor and the images you wish to watch). ("480p" indicates the 480p/576p resolution setting.)	<b>AUTO</b> PURE 480p 720p 1080i 1080p 1080/24p 4K 4K/24p
<b>PCINEMA</b> (PureCinema) <c, e>	This setting optimizes the operation of the progressive scanning circuit for playing film materials. Normally set it to <b>AUTO</b> . If the picture seems unnatural, switch this to <b>ON</b> or <b>OFF</b> .	<b>AUTO</b> ON OFF
<b>P.MOTION</b> (Progressive Motion) <c, e>	Adjusts the motion and still picture quality when video output is set to progressive.	◀ -4 to +4 ▶ Default: <b>0</b>

Setting	What it does	Option(s)
<b>STREAM</b> (Stream Smoother) <e>	This improves elements that reduce picture quality mainly noticeable in network contents, such as mosquito noise and block noise. When <b>AUTO</b> is selected, this unit's Stream Smoother function automatically turns on when network contents are played on the player supporting Stream Smoother Link and connected to this unit by HDMI (assuming that integrated operation with the Control with HDMI function is set). (Stream Smoother Link)	<b>OFF</b> ON  AUTO
<b>V.ADJ</b> (Advanced Video Adjust)	Sets the optimum picture quality for the type of monitor that is connected. Select <b>PDP</b> for plasma displays, <b>LCD</b> for liquid crystal monitors, <b>FPJ</b> for front projectors, <b>PRO</b> for professional monitors. If you want to adjust the picture quality settings to your personal tastes, select <b>MEMORY</b> .	<b>PDP</b> LCD FPJ PRO MEMORY
<b>YNR</b> <d, e>	Reduces noise in the luminance (Y) signal.  (The image is only an example for checking the effect.)	◀ 0 to +8 ▶ Default: <b>0</b>
<b>CNR</b> <d, e>	Reduces noise in the input's color (C) signal.  (The image is only an example for checking the effect.)	◀ 0 to +8 ▶ Default: <b>0</b>
<b>BNR</b> <d, e>	Reduces block noise (block-shaped distortion generated upon MPEG compression) in the picture.  (The image is only an example for checking the effect.)	◀ 0 to +8 ▶ Default: <b>0</b>
<b>MNR</b> <d, e>	Reduces mosquito noise (distortion generated at the contours of the picture upon MPEG compression) in the picture.  (The image is only an example for checking the effect.)	◀ 0 to +8 ▶ Default: <b>0</b>



Setting	What it does	Option(s)
<b>DETAIL</b> <d, e>	Adjusts how sharp edges appear. 	◀ 0 to +8 ▶ Default: 0
(The image is only an example for checking the effect.)		
<b>BRIGHT</b> (Brightness) <d, e>	Adjusts the overall brightness. 	◀ -6 to +6 ▶ Default: 0
(The image is only an example for checking the effect.)		
<b>CONTRAST</b> <d, e>	Adjusts the contrast between light and dark. 	◀ -6 to +6 ▶ Default: 0
(The image is only an example for checking the effect.)		
<b>HUE</b> <d, e>	Adjusts the red/green balance. 	◀ -6 to +6 ▶ Default: 0
(The image is only an example for checking the effect.)		

Setting	What it does	Option(s)
<b>CHROMA</b> (Chroma Level) <d, e>	Adjusts saturation from dull to bright. 	◀ -6 to +6 ▶ Default: 0
(The image is only an example for checking the effect.)		
<b>BLK SETUP</b> (Black Setup) <f>	Sets the black level according to the video input signal. Normally select <b>7.5</b> . If the dark parts of the picture are all black with this setting, select <b>0</b> .	<b>7.5</b> 0
<b>ASP</b> (Aspect) <g>	Specifies the aspect ratio when input signals are output at the HDMI output. Make your desired settings while checking each setting on your display (if the image doesn't match your monitor type, cropping or black bands appear).	<b>THROUGH</b> NORMAL

- a
- The default value changes depending on the type of input ([page 74](#)).
  - If the video picture deteriorates when this settings is switched **ON**, switch it **OFF**.
- b
- When set to a resolution with which the TV (monitor) is not compatible, no picture is output. Also, in some cases no picture will be output due to copyright protection signals. In this case, change the setting.
  - When **AUTO** is selected, the resolution is selected automatically according to the capacity of the TV (monitor) connected by HDMI. When **PURE** is selected, the signals are output with the same resolution as when input (see [About the video converter](#) on [page 24](#)).
  - When **1080/24p** or **4K/24p** is selected, the movement may be unnatural or the picture unclear, depending on the video signal being input. In this case, set the resolution to something other than **1080/24p** or **4K/24p**.
  - When **PURE** is selected and the input signal is 480i, the on-screen display cannot be displayed.
- c
- P.MOTION** is disabled when **PCINEMA** is set to **ON**.
  - This setting have the effect only for pictures recorded in the interlaced scan format (480i/576i or 1080i signals).
- d
- Adjustment is not possible unless **V.ADJ** (Advanced Video Adjust) is set to **MEMORY**.
- e
- This setting is only displayed when the video signals below are being input:
    - 480i, 576i, 480p, 576p, 720p, 1080i analog video signals
    - 480i, 576i, 480p, 576p, 720p, 1080i, 1080p, 1080p24 HDMI video signals
- f
- This adjustment is only possible when 480i signals are being input from the composite video jacks.
- g
- If the image doesn't match your monitor type, adjust the aspect ratio on the source component or on the monitor.
  - This setting is only displayed when 480i/p or 576i/p video signals are being input.



## Switching the output (OUTPUT PARAMETER)

You can press **OUT P.** to switch the output of speaker terminals or HDMI terminals to be played.

### Switching the speaker terminals

If you selected **Normal(SB/FH)**, **Normal(SB/FW)** or **Speaker B** at [Speaker system setting](#) on [page 89](#), you can switch between speakers using the **OUT P.** button. If you selected **Front Bi-Amp, ZONE 2** or **HDZONE**, the button will simply switch your main speaker terminals on or off.

#### 1 Press OUT P..

- You can perform the same operation by pressing **SPEAKERS** on the front panel.

#### 2 Use ↑/↓ to select 'SP'.

#### 3 Use ←/→ to switch the speaker terminals to be played.

As mentioned above, if you have selected **Front Bi-Amp, ZONE 2** or **HDZONE**, the button will simply switch your main speaker terminal (A) on or off.

Press repeatedly to choose a speaker terminal option:

When you select **Normal(SB/FH)**, you can select from:

- SP: SB/FH ON** – Surround back or front height channels are added to the front, center and surround channels (maximum 5 channels) and a maximum of 7 channels are output. The surround back and front height channels are switched automatically according to the audio input signal.
- SP: SB ON** – Surround back channels are added to the front, center and surround channels (maximum 5 channels) and a maximum of 7 channels are output.
- SP: FH ON** – Front height channels are added to the front, center and surround channels (maximum 5 channels) and a maximum of 7 channels are output.
- SP: OFF** – No sound is output from the speakers.

When you select **Normal(SB/FW)**, you can select from:

- SP: SB/FW ON** – Surround back or front wide channels are added to the front, center and surround channels (maximum 5 channels) and a maximum of 7 channels are output. The surround back and front wide channels are switched automatically according to the audio input signal.
- SP: SB ON** – Surround back channels are added to the front, center and surround channels (maximum 5 channels) and a maximum of 7 channels are output.
- SP: FW ON** – Front wide channels are added to the front, center and surround channels (maximum 5 channels) and a maximum of 7 channels are output.
- SP: OFF** – No sound is output from the speakers.

When you select **Speaker B**, you can select from:

- SP: A ON** – Sound is output from the A-speaker terminals (up to 7 channels (including surround back channels), depending on the source).
- SP: B ON** – Sound is output from the two speakers connected to the B-speaker terminals. Multichannel sources will not be heard.
- SP: A+B ON** – Sound is output from the A-speaker terminals (up to 5 channels, depending on the source), the two speakers connected to the B-speaker terminals, and the subwoofer. The sound from the B-speaker terminals will be the same as the sound from the A-speaker terminals (multichannel sources will be downmixed to 2 channels).
- SP: OFF** – No sound is output from the speakers.



#### Notes

- The subwoofer output depends on the settings you made in [Manual speaker setup](#) on [page 89](#). However, if **SP: B ON** is selected above, no sound is heard from the subwoofer (the LFE channel is not downmixed).
- All speaker systems (except **Speaker B** connections) are switched off when headphones are connected.

## Switching the HDMI output

Set which terminal to use when outputting video and audio signals from the HDMI output terminals.

The **HDMI OUT 1** terminal is compatible with the **Control** with HDMI function.

#### 1 Press OUT P..

#### 2 Use ↑/↓ to select 'OUT 1/2'.

#### 3 Use ←/→ to select the setting.

Please wait a while when **Please wait ...** is displayed.

The output switches among **OUT 1+2**, **OUT 1**, **OUT 2** and **OFF** each time the button is pressed.

- The synchronized amp mode is canceled when the HDMI output is switched. If you wish to use the synchronized amp mode, switch to **OUT 1**, then select the synchronized amp mode on the TV using the TV's remote control.
- When **MAIN/HDZONE** is set to **HDZONE**, it is not possible to switch to **OUT 2** ([page 94](#)).
- Only signals input in HDMI format can be played with the **HDMI OUT 2** terminal.

## Changing the channel level while listening

Using the channel level settings, you can adjust the overall balance of your speaker system, an important factor when setting up a home theater system.

#### 1 Press CH LV..

#### 2 Use ↑/↓ to select the channel you wish to adjust.

#### 3 Adjust the volume using ←/→.

The volume can be adjusted in the range of **-12.0dB** to **+12.0dB**, 0.5 dB steps.

#### 4 When you're finished, press RETURN.

## Input Volume Absorber

This can be used to correct for the difference in volume between input sources.

#### 1 Switch to the input whose volume you want to adjust.

#### 2 Press CH LV..

#### 3 Use ↑/↓ to select 'ALL'.

#### 4 Adjust the volume using ←/→.

The volume can be adjusted in the range of **-12.0dB** to **+12.0dB**, 0.5 dB steps.

#### 5 When you're finished, press RETURN.





## Using the MULTI-ZONE controls

The following steps use the front panel controls to adjust the sub zone volume and select sources. See [ZONE 2 remote controls](#) and [HDZONE remote controls](#) on [page 72](#).



### Important

- The settings must be changed at **ZONE Setup** in order to use the **HDZONE** function ([page 94](#)).

### 1 Press MULTI-ZONE ON/OFF on the front panel.

Each press selects a MULTI-ZONE option:

- ZONE 2 ON** – Turns on the MULTI-ZONE feature for **ZONE 2**.
- Z2&HDZONE ON** – Turns on the MULTI-ZONE feature for **ZONE 2** and the **HDZONE**.
- HDZONE ON** – Turns on the MULTI-ZONE feature for the **HDZONE**.
- MULTI ZONE OFF** – Switches the MULTI-ZONE feature off

The **MULTI-ZONE** indicator lights when the MULTI-ZONE control has been switched ON.

### 2 Press MULTI-ZONE CONTROL on the front panel to select the sub zone(s) you want.

- When the receiver is on, make sure that any operations for the sub zone are done while ZONE and your selected sub zone(s) show in the display. If this is not showing, the front panel controls affect the main zone only.

If the receiver is in standby, the display is dimmed, and ZONE and your selected sub zone(s) continue to show in the display.

### 3 Use the INPUT SELECTOR dial to select the source for the sub zone.

For example, **ZONE 2 DVD** sends the source connected to the **DVD** inputs to the sub room (**ZONE 2**).

- If you select **TUNER**, you can use the tuner controls to select a preset station (see [Saving station presets](#) on [page 48](#) if you're unsure how to do this). The tuner cannot be tuned to more than one station at a time. Therefore, changing the station in one zone also changes the station in the other zone. Please be careful not to change stations when recording a radio broadcast.

### 4 Use the MASTER VOLUME dial to adjust the volume for the sub zone.

When **Speaker System** is set to anything other than **ZONE 2**, the volume output from the receiver's **AUDIO ZONE 2 OUT** terminals can be fixed to  $-40$  dB or  $0$  dB and the volume can be adjusted from the connected amplifier. If you want to adjust the volume from the connected amplifier, see [ZONE Setup](#) on [page 94](#).

### 5 When you're finished, press MULTI-ZONE CONTROL again to return to the main zone controls.

You can also press **MULTI-ZONE ON/OFF** on the front panel to switch off all output to the sub zone.

- You won't be able to switch the main zone off completely unless you've switched off the MULTI-ZONE control first.
- If you don't plan to use the MULTI-ZONE feature for a while, turn off the power in both the sub and main rooms so that this receiver is in standby.



### Note

When the network function or **iPod/USB** input is selected using HDZONE, the video converter function is disabled. For that reason, video connected with the video cable or component cable is not output from the HDMI terminal. Also, upscaling of the HDMI input video cannot be performed. To enable the video converter function, turn off HDZONE or set HDZONE to some other input.

## ZONE 2 remote controls

Before operation, hold down **Z2** on the remote control (for 1.5 seconds) until the remote control LED flashes one time.

The following table shows the possible ZONE 2 remote controls:

Button(s)	What it does
⏻	Switches on/off power in the sub zone.
<b>INPUT SELECT</b>	Use to select the input function in the sub zone.
Input function buttons	Use to select the input function directly (this may not work for some functions) in the sub zone.
<b>VOLUME +/-</b> <a>	Use to set the listening volume in the sub zone.
<b>MUTE</b> <a>	Mutes the sound or restores the sound if it has been muted (adjusting the volume also restores the sound).

- a • The volume cannot be adjusted on the receiver if **Volume Level** at **ZONE 2 Setup** under **ZONE Setup** is set to  **$-40$  dB Fixed** or  **$0$  dB Fixed**.



### Note

- The **Z3** button is not used with this unit.

## HDZONE remote controls

Before operation, hold down **HDZ** on the remote control (for 1.5 seconds) until the remote control LED flashes one time.

The following table shows the possible HDZONE remote controls:

Button(s)	What it does
⏻	Switches on/off power in the HDZONE.
<b>INPUT SELECT</b>	Use to select the input function in the HDZONE.
Input function buttons	Use to select the input function directly (this may not work for some functions) in the HDZONE.
<b>VOLUME +/-</b> <a>	Use to set the listening volume in the HDZONE.
<b>MUTE</b> <a>	Mutes the sound or restores the sound if it has been muted (adjusting the volume also restores the sound).

- a You can operate this only when **Speaker System** is set to **HDZONE**.





## Network settings from a web browser

Network settings and Pandora account settings can be made using the browser on a computer connected to the same LAN as the receiver.

- 1 Press **⏻** **STANDBY/ON** to switch on the receiver.
- 2 Turn on the computer's power and launch the Internet browser.
- 3 Input the receiver's IP address into the browser's address input field.

Access the IP address "http://(the receiver's IP address)" from a web browser. You can display the IP address of the unit on the unit's display by pressing the **STATUS** button on the remote control.

When connected with the receiver, the AVNavigator menu screen appears in the browser.

- 4 On the AVNavigator menu screen, select **Network Setup**.
- 5 Select the item you want to set.

## Using the sleep timer

The sleep timer switches the receiver into standby after a specified amount of time so you can fall asleep without worrying about the receiver being left on all night. Use the remote control to set the sleep timer.

- Press **SLEEP** repeatedly to set the sleep time.



- You can check the remaining sleep time at any time by pressing **SLEEP** once. Pressing repeatedly will cycle through the sleep options again.
- The sleep timer is valid for all zones. If any zone is on, the sleep timer continues functioning.

## Dimming the display

You can choose between four brightness levels for the front panel display. Note that when selecting sources, the display automatically brightens for a few seconds.

Turning off the display is effective for suppressing noise from the display that affects sound quality.

- Press **DIMMER** repeatedly to change the brightness of the front panel display.
- You can also choose to turn the display off. In this case, the **FL OFF** indicator lights.

## Checking your system settings

Use the status display screen to check your current settings for features such as surround back channel processing and your current MCACC preset.

- 1 Press **STATUS**.
- 2 Use **↑/↓** to check the system setting.

The information on the main unit display switches as shown below each time one of the buttons is pressed.  
 IP address ↔ Audio format ↔ Sampling frequency ↔ MCACC memory ↔ Auto phase control plus correction value ↔ Input source to be played in **ZONE 2** ↔ Input source to be played in **HDZONE** ↔ HDMI output setting ↔ Subzone to which **HDZONE** is output

- For some settings, some items are not displayed.
- 3 When you're finished, press **STATUS** again to switch off the display.



## Resetting the system

Use this procedure to reset all the receiver's settings to the factory default. Use the front panel controls to do this. Set MULTI-ZONE to **MULTI ZONE OFF**.

- Disconnect the iPod and USB memory device from the receiver beforehand.
- Set the **Control** with HDMI to **OFF** (see [HDMI Setup](#) on [page 63](#)).

**1 Switch the receiver into standby.**

**2 While holding down ENTER on the front panel, press  STANDBY/ON.**

The display shows **RESET ◀ NO ▶**.

**3 Select 'RESET' using PRESET  / , then press ENTER on the front panel.**

The display shows **RESET? OK**.

**4 Press ENTER to confirm.**

**OK** appears in the display to indicate that the receiver has been reset to the factory default settings.

- Note that all settings will be saved, even if the receiver is unplugged.

## Default system settings

Setting	Default	
Digital Video Converter	<b>OFF</b>	
<b>SPEAKERS</b>	<b>SB/FH ON</b>	
Speaker System	<b>Normal(SB/FH)</b>	
Speaker Setting	Front	<b>SMALL</b>
	Center	<b>SMALL</b>
	FH/FW	<b>SMALL</b>
	Surr	<b>SMALL</b>
	SB	<b>SMALLx2</b>
	SW	<b>YES</b>
Surround Position	<b>ON SIDE</b>	
Crossover	<b>80Hz</b>	
X-Curve	<b>OFF</b>	
DIMMER	Brightest	
<b>Inputs</b>		
See <a href="#">Input function default and possible settings</a> on <a href="#">page 40</a> .		
Input Volume Absorber	All Inputs	<b>0dB</b>
<b>HDMI</b>		
HDMI Audio	<b>AMP</b>	
Control	<b>OFF</b>	
Control Mode	--- (OFF)	
ARC (Audio Return Channel)	--- (OFF)	
PQLS	--- (AUTO)	
Standby Through	<b>OFF</b>	
<b>DSP</b>		
Power On Level	<b>LAST</b>	
Volume Limit	<b>OFF</b>	
Mute Level	<b>FULL</b>	

Setting	Default	
Phase Control	<b>ON</b>	
Auto Sound Retriever	iPod/USB, INTERNET RADIO, PANDORA, MEDIA SERVER, FAVORITES, ADAPTER PORT input function	<b>ON</b>
	Other input functions	<b>OFF</b>
Sound Delay	<b>0 ms</b>	
Dual Mono	<b>CH1</b>	
DRC	<b>AUTO</b>	
LFE Attenuate	<b>0dB</b>	
Auto delay	<b>OFF</b>	
Digital Safety	<b>OFF</b>	
Effect Level	ALC (Auto Level Control)	<b>50</b>
	Center Width	<b>3</b>
	Dimension	<b>0</b>
<input checked="" type="checkbox"/> PL II Music Options	Panorama	<b>OFF</b>
	Neo:X Options	Center Gain
<input checked="" type="checkbox"/> PL IIz Options	Height Gain	<b>MID</b>
	All Inputs	Listening Mode (2 ch/multi ch)
	Listening Mode (Headphones)	<b>STEREO</b>
See also <a href="#">Setting the Audio options</a> on <a href="#">page 67</a> for other default DSP settings.		
<b>MCACC</b>		
MCACC Position Memory	<b>M1. MEMORY 1</b>	
Channel Level (M1 to M6)	0.0 dB	
Speaker Distance (M1 to M6)	10'00"	
Standing Wave (M1 to M6)	ATT of all channels/filters	0.0 dB
	SWch Wide Trim	0.0 dB
EQ Data (M1 to M6)	All channels/bands	0.0 dB
	EQ Wide Trim	0.0 dB
<b>Network</b>		
Network Standby	<b>OFF</b>	
DHCP	<b>ON</b>	



## Controlling the rest of your system

About the Remote Setup menu.....	76
Operating multiple receivers.....	76
Setting the remote to control other components.....	76
Selecting preset codes directly.....	76
Programming signals from other remote controls.....	77
Erasing one of the remote control button settings.....	77
Erasing all learnt settings that are in one input function.....	78
Using All Zone Standby.....	78
Setting the switching time of AV amplifier operation mode.....	78
Resetting the remote control settings.....	78
Controlling components.....	79



## About the Remote Setup menu

The Remote Setup mode is set by pressing the number button while pressing **RCU SETUP**. The different items on the Remote Setup menu are described below. For their setting procedures, refer to the explanations for the respective items.

Setting	What it does
<b>Change RC mode</b>	If you have multiple Pioneer receivers, amplifiers, etc., this setting can be used to prevent other units from operating simultaneously when the remote control unit is operated. See <a href="#">Operating multiple receivers</a> on <a href="#">page 76</a> .
<b>Preset recall</b>	Preset codes can be set for the various input functions. The remote control codes of a number of other devices (including products of other brands) are preset in the remote control to allow these devices to be operated. See <a href="#">Selecting preset codes directly</a> on <a href="#">page 76</a> .
<b>Code learning</b>	If the desired operations cannot be performed even though you have set the preset codes, the remote control signals of other devices can be learned directly. See <a href="#">Programming signals from other remote controls</a> on <a href="#">page 77</a> .
<b>Erase learning</b>	This function is used to erase remote control codes that have been learned. Codes learned for the different input functions can be erased individually. See <a href="#">Erasing one of the remote control button settings</a> on <a href="#">page 77</a> .
<b>Reset function</b>	This is a function for resetting preset codes that have been set. Key resetting can be done for individual input functions. See <a href="#">Erasing all learnt settings that are in one input function</a> on <a href="#">page 78</a> .
<b>Operation mode switching time</b>	You can set to automatically switch to AV amplifier operation mode when a certain period of time elapses after remote operation of each input function is finished. See <a href="#">Setting the switching time of AV amplifier operation mode</a> on <a href="#">page 78</a> .
<b>All reset</b>	This is a function for resetting all remote control unit settings you have made to the defaults set upon shipment from the factory. See <a href="#">Resetting the remote control settings</a> on <a href="#">page 78</a> .



### Notes

- You can cancel or exit any of the steps by pressing **RCU SETUP**.
- After one minute of inactivity, the remote automatically exits the operation.

## Operating multiple receivers

Up to four receivers can be operated discretely using this receiver's remote control when using multiple receivers, provided they are of the same model as this receiver. The receiver to be operated is switched by inputting the preset code to set the remote control setting.

- Set the remote modes on the receivers before using this function (see [Remote Control Mode Setup](#) on [page 93](#)).

### 1 Press and hold RCU SETUP, then press '4' for three seconds.

Release the button after the LED flashes once. The LED continues to flash.

- To cancel the preset setup mode press **RCU SETUP**.

### 2 Press the number button for the receiver ("Receiver 1" to "Receiver 4") you wish to operate.

For example, to operate "Receiver 2", press '2'.

If the LED lights for one second, the setting has been successfully completed.

When the preset code is input, the LED flashes three times to indicate that the setting has failed.

## Setting the remote to control other components

Most components can be assigned to one of the input function buttons (such as **DVD** or **CD**) using the component's manufacturer preset code stored in the remote.

However, there are cases where only certain functions may be controllable after assigning the proper preset code, or the codes for the manufacturer in the remote control will not work for the model that you are using. If you can't find a preset code that matches the component you want to control, you can still teach the remote individual commands from another remote control (see [Programming signals from other remote controls](#) on [page 77](#)).

- With the **TV** buttons, the TV can be operated regardless of the input set for the remote control's operation mode. When using one TV set, we recommend assigning the same TV's preset codes to the **TV INPUT** button and the **TV** button. When using two TV sets, for better convenience assign the TV connected to the **MONITOR OUT** terminals to the **TV INPUT** button, the other TV to the **TV** button.
- Devices may be assigned to the following input function buttons.

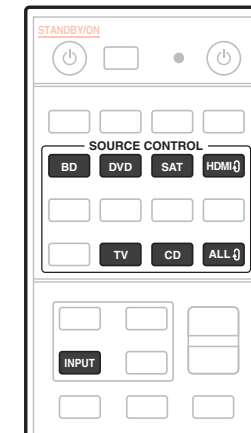

## Selecting preset codes directly

### 1 Press and hold RCU SETUP, then press '1' for three seconds.

Release the button after the LED flashes once. The LED continues to flash.

- To cancel the preset setup mode press **RCU SETUP**.

### 2 Press the input function button for the component you want to control.

To assign the preset codes of the TV to be operated with the **TV** function, press the **TV INPUT** button. The LED of the remote control lights.

### 3 Use the number buttons to enter the 4-digit preset code.

See [Preset code list](#) on [page 118](#).

If the LED lights for one second and continues to flash, the setting has been successfully completed.

When the preset code is fully input, the LED flashes three times to indicate that the setting has failed. If this happens, enter the 4-digit preset code again.

### 4 Repeat steps 2 through 3 for the other components you want to control.

To try out the remote control, switch the component on or off (into standby) by pressing **⏻ SOURCE**. If it doesn't seem to work, select the next code from the list (if there is one).

### 5 Press RCU SETUP to exit the preset setup mode.



## Programming signals from other remote controls

If the preset code for your component is not available, or the available preset codes do not operate correctly, you can program signals from the remote control of another component. This can also be used to program additional operations (buttons not covered in the presets) after assigning a preset code.

The remote can store about 120 preset codes from other components (this has been tested with codes of Pioneer format only).

Certain buttons represent operations that cannot be learned from other remote controls. The buttons available are shown below:

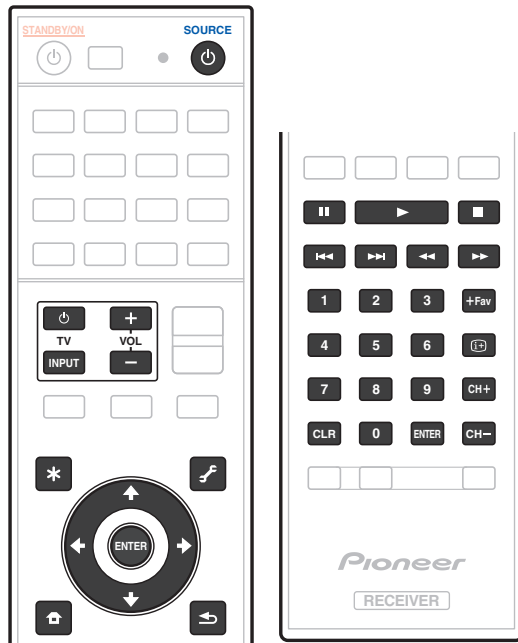

### 1 Press and hold RCU SETUP, then press '2' for three seconds.

Release the button after the LED flashes once. The LED continues to flash.

- To "learn" codes at the **TV** buttons, proceed to step 3.
- To cancel the preset setup mode press **RCU SETUP**.

### 2 Press the input function button for the component you want to control.

The LED blinks once and flashes continuously.

### 3 Point the two remote controls towards each other, then press the button that will be doing the learning on this receiver's remote control.

The LED flashes once, then stops flashing, remaining lit.

- The remote controls should be 3 cm (1 inch) apart.

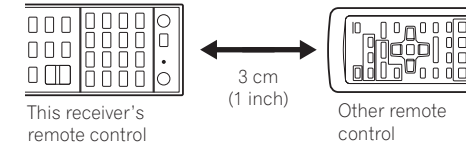

### 4 Press the corresponding button on the other remote control that is sending (teaching) the signal to this receiver's remote control.

If the LED lights for one second and continues to flash, the setting has been successfully completed.

- If the LED flashes for five seconds, it means the memory is full. See [Erasing all learnt settings that are in one input function on page 78](#) to erase a programmed button you're not using to free up more memory (note that some signals may take more memory than others).
- Note that interference from TVs or other devices will sometimes result in the remote control learning the wrong signal.
- Some commands from other remote controls cannot be learned, but in most cases the remotes just need to be moved closer together or farther apart.

### 5 To program additional signals for the current component repeat steps 3 and 4.

To program signals for another component, exit and repeat steps 2 through 4.

### 6 Press RCU SETUP to exit the programming mode.

## Erasing one of the remote control button settings

This erases one of the buttons you have programmed and restores the button to the factory default.

### 1 Press and hold RCU SETUP, then press '8' for three seconds.

Release the button after the LED flashes once. The LED continues to flash.

- To erase operations registered at the **TV** buttons, proceed to step 3.
- To cancel the preset setup mode press **RCU SETUP**.

### 2 Press the input function button corresponding to the command to be erased.

The LED flashes once.

### 3 Press and hold the button to be erased for three seconds.

If the LED lights for one second, the erasing has been successfully completed.

### 4 Repeat step 3 to erase other buttons.

### 5 Press RCU SETUP to exit the erasing mode.



## Erasing all learnt settings that are in one input function

This operation erases all the operational settings of other devices that have been programmed in one input function, and restores the factory default.

This function is handy for erasing all data programmed for devices no longer being used.

### 1 Press and hold RCU SETUP, then press '9' for three seconds.

Release the button after the LED flashes once. The LED continues to flash.

- To cancel the preset setup mode press **RCU SETUP**.

### 2 Press and hold the input function button corresponding to the command to be erased for three seconds.

To erase the operations registered at all the **TV** buttons, press the **TV INPUT** button for 3 seconds.

If the LED lights for one second, the erasing has been successfully completed.

## Using All Zone Standby

The All Zone Standby can be used to turn all zones to OFF when the receiver's power is switched to standby.

Also, when using separate Pioneer amplifiers/receivers for the sub zones, they can also be set to standby simultaneously.

- In order to set the power of amplifiers/receivers connected to sub zones to the standby mode, the connected amplifiers/receivers must be installed or connected in such a way that they can receive remote control signals.
- The power of the amplifiers/receivers can be switched to standby with this operation even when using multiple Pioneer amplifiers/receivers and their **Remote Control Mode** have been changed.

### 1 Press ALL ZONE STBY.

The LED continues to flash.

### 2 Press STANDBY/ON.

The receiver's power switches to standby and all zones are turned off.

## Setting the switching time of AV amplifier operation mode

- Default setting: The AV amplifier operation mode is not switched automatically.

After pressing **SOURCE CONTROL** to operate another device, you need to press **MAIN RECEIVER** to switch the mode to AV amplifier operation mode to operate this receiver.

You can set to automatically switch to AV amplifier operation mode when a certain period of time elapses after remote operation of each input function is finished. See [Setting the switching time of AV amplifier operation mode](#) on [page 78](#).

### 1 Press and hold RCU SETUP, then press '5' for three seconds.

The LED flashes once.

### 2 Press the number buttons of the time you wish to set.

- **1** – The mode is not automatically switched to AV amplifier operation mode.
- **2** – Switches in five minute.
- **3** – Switches in three minute.
- **4** – Switches in one minute.
- **5** – Switches in 30 seconds.

### 3 Press RCU SETUP to exit the setup.

## Resetting the remote control settings

Use this procedure to reset all the remote control's settings to the factory default.

- When preset codes are set, all the signals learned in the input function buttons are cleared. This function is convenient when you want to reset some but not all of input function buttons.

### 1 Press and hold RCU SETUP, then press '0' for three seconds.

Release the button after the LED flashes once. The LED continues to flash.

### 2 Hold down the ENTER button for five seconds.

If the LED lights for one second, the erasing has been successfully completed.

## Default preset codes

Input function button	Preset code
BD	2255
DVD	2197
HDMI	2144
TV	0305
CD	5000
SAT/CBL	6329
TV (INPUT)	0305
ALL 0	2034



### Controlling components

This remote control can control components after entering the proper codes (see [Setting the remote to control other components](#) on [page 76](#) for more on this). Use the input function buttons to select the component.

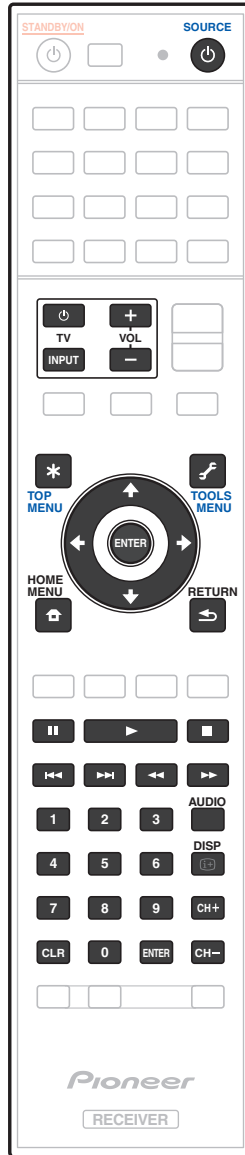

### TV and Audio/Video components

Button(s)	TV	TV (Monitor)	BD/DVD	HDD/BDR/DVR	VCR	SAT/CATV
⏻ SOURCE	POWER ON/OFF	POWER ON/OFF	POWER ON/OFF	POWER ON/OFF	POWER ON/OFF	POWER ON/OFF
Number buttons	numerics	numerics	numerics	numerics	numerics	numerics
CLR	• (dot)	KURO LINK	CLEAR	+	—	*
ENTER (CLASS)	CH ENTER	CH ENTER	ENTER	ENTER	—	ENTER
*	EXIT/INFO	EXIT	TOP MENU	TOP MENU	—	LIST
🔧	TOOLS/GUIDE/EPG	USER MENU	TOOLS <a>	GUIDE	—	GUIDE
⬆️/⬇️/⬅️/➡️	⬆️/⬇️/⬅️/➡️	⬆️/⬇️/⬅️/➡️	⬆️/⬇️/⬅️/➡️	⬆️/⬇️/⬅️/➡️	—	⬆️/⬇️/⬅️/➡️
ENTER	ENTER	ENTER	ENTER	ENTER	—	ENTER
🏠	HOME MENU	HOME MENU	HOME MENU	HOME MENU	—	HOME MENU
↶	RETURN	RETURN	RETURN	RETURN	—	RETURN
▶	—	—	▶	▶	▶	▶
⏸	—	AUTO SETUP	⏸	⏸	⏸	⏸
■	—	FREEZE	■	■	■	■
⏪	—	—	⏪	⏪	⏪	⏪
⏩	—	—	⏩	⏩	⏩	⏩
⏮	ANT	AV SELECTION	⏮	⏮	—	⏮
⏭	—	SCREEN SIZE	⏭	⏭	—	⏭
AUDIO	AUDIO	AUDIO	AUDIO	AUDIO	AUDIO	AUDIO
DISP	DISPLAY	DISPLAY	DISPLAY	DISPLAY	—	DISPLAY/INFO
CH +/-	CH +/-	CH +/-	Subtitle (CH +) Popup menu (CH -) <a>	Subtitle (CH +) or CH +/-	CH +/-	CH +/-

a. Controls for BD.



## Audio/Video components

Button(s)	LD	CD/CD-R/SACD	MD/DAT	TAPE
⊕ SOURCE	POWER ON/OFF	POWER ON/OFF	POWER ON/OFF	POWER ON/OFF
Number buttons	<i>numerics</i>	<i>numerics</i>	<i>numerics</i>	—
<b>CLR</b>	+10	>10/CLEAR	CLEAR <a>	CLEAR
<b>ENTER</b> (CLASS)	ENTER	DISC/ENTER	OPEN/CLOSE <a>	ENTER
<b>*</b>	TOP MENU	—	—	MS←
	—	LEGATO LINK <b>	—	MS→
↑/↓/←/→	↑/↓/←/→	—	—	/■/◀/▶
<b>ENTER</b>	ENTER	—	—	—
	—	SACD SETUP <b>	—	—
	RETURN	—	—	—
▶	▶	▶	▶	▶
⏪	⏪	⏪	⏪	⏪
■	■	■	■	■
◀	◀	◀	◀	◀
▶▶	▶▶	▶▶	▶▶	▶▶
◀◀	◀◀	◀◀	◀◀	◀◀
▶▶	▶▶	▶▶	▶▶	▶▶
<b>AUDIO</b>	AUDIO	PURE AUDIO <b>	—	—
<b>DISP</b>	DISPLAY/INFO	TIME <b>	—	—

a Controls for MD.

b Controls for SACD.

## TV (Projector)

Button(s)	TV (Projector)
⊕ SOURCE	POWER ON
<b>1</b>	MOVIE
<b>2</b>	STANDARD
<b>3</b>	DYNAMIC
<b>4</b>	USER1
<b>5</b>	USER2
<b>6</b>	USER3
<b>7</b>	COLOR+
<b>8</b>	SHARP+
<b>9</b>	GAMMA
<b>0</b>	COLOR-
<b>CLR</b>	SHARP-
<b>ENTER</b> (CLASS)	COLOR TEMP
<b>*</b>	EXIT
	INFO
↑/↓/←/→	↑/↓/←/→
<b>ENTER</b>	ENTER
	TEST
	HIDE
	MENU
◀	HDMI1
▶	HDM 2
▶▶	COMP.
◀◀	VIDEO
⏪	S-VIDEO
■	BRIGHT-
▶▶	BRIGHT+
<b>AUDIO</b>	POWER OFF
<b>DISP</b>	ASPECT
<b>CH +/-</b>	CONTRAST +/-







## The Advanced MCACC menu

Making receiver settings from the Advanced MCACC menu .....	82
Automatic MCACC (Expert).....	82
Manual MCACC setup .....	84
Checking MCACC Data .....	86
Data Management.....	87



## Making receiver settings from the Advanced MCACC menu

The Advanced MCACC (Multi Channel ACoustic Calibration) system was developed in Pioneer's laboratories with the aim of making it possible for home users to perform adjustments of the same level as in a studio easily and with high precision. The acoustic characteristics of the listening environment are measured and the frequency response is calibrated accordingly to allow high precision, automatic analysis and optimal calibration of the sound field to bring it closer to a studio environment than ever before. Furthermore, while it was previously difficult to eliminate standing waves, this receiver is equipped with a standing wave control function using a unique process to perform acoustic analysis and reduce their influence.

This section describes how to calibrate the sound field automatically and fine-adjust the sound field data manually.

### 1 Press **STANDBY/ON** to switch on the receiver and your TV.

Make sure that the TV's video input is set to this receiver.

### 2 Press **MAIN RECEIVER** to the receiver operation mode, then press **HOME MENU**.

A Graphical User Interface (GUI) screen appears on your TV. Use **↑/↓/←/→** and **ENTER** to navigate through the screens and select menu items. Press **RETURN** to exit the current menu.

- Press **HOME MENU** at any time to exit the **HOME MENU**.

### 3 Select 'Advanced MCACC' from the HOME MENU, then press **ENTER**.

### 4 Select the setting you want to adjust.

- **Full Auto MCACC** – See [Automatically conducting optimum sound tuning \(Full Auto MCACC\)](#) on [page 38](#) for a quick and effective automatic surround setup.
- **Auto MCACC** – See [Automatic MCACC \(Expert\)](#) on [page 82](#) for a more detailed MCACC setup.
- **Manual MCACC** – Fine-tunes your speaker settings and customizes the Acoustic Calibration EQ (see [Manual MCACC setup](#) on [page 84](#)).
- **Demo** – No settings are saved and no errors occur. When the speakers are connected to this receiver, the test tone is output repeatedly. Press **RETURN** to cancel the test tone.

## Automatic MCACC (Expert)

If your setup requires more detailed settings than those provided in [Automatically conducting optimum sound tuning \(Full Auto MCACC\)](#) on [page 38](#), you can customize your setup options below. You can calibrate your system differently for up to six different MCACC presets, which are useful if you have different listening positions depending on the type of source (for example, watching movies from a sofa, or playing a video game close to the TV).



### Important

- Make sure the microphone/speakers are not moved during the Auto MCACC Setup.
- The screen saver will automatically appear after five minutes of inactivity.



### CAUTION

- The test tones used in the Auto MCACC Setup are output at high volume.

### 1 Select 'Auto MCACC' from the Advanced MCACC menu, then press **ENTER**.

If the **Advanced MCACC** screen is not displayed, refer to [Making receiver settings from the Advanced MCACC menu](#) on [page 82](#).

### 2 Select the parameters you want to set.

Use **↑/↓** to select the item, then use **←/→** to set.

- **Auto MCACC** – The default is **ALL** (recommended), but you can limit the system calibration to only one setting (to save time) if you want.
  - When data measurement is taken (after selecting **ALL** or **Keep SP System**), the reverb characteristics data (both before- and after-calibration) that this receiver had been storing will be overwritten.
  - When measurement is performed with other than **SYMMETRY** (after selecting **ALL** or **Keep SP System**), the reverberation characteristics after calibration cannot be predicted, so the graph for the characteristics after calibration ("After") cannot be displayed. If you will need to display the graph for the characteristics after calibration ("After"), take the measurement using the **EQ Professional** menu in the **Manual MCACC** setup ([page 84](#)).
  - The **EQ Pro & S-Wave** measurement is also taken when **ALL** or **Keep SP System** is selected. See [Acoustic Calibration EQ Professional](#) on [page 85](#) for more on this.
  - Either effect of Acoustic Calibration EQ Professional and Standing Wave can be switched on and off in the respective MCACC preset. For details, see [Setting the Audio options](#) on [page 67](#).
- **EQ Type** (only available when the **Auto MCACC** Menu above is **EQ Pro & S-Wave**) – This determines how the frequency balance is adjusted. After a single calibration is performed, each of the following three correction curves can be stored separately in the MCACC memory.
  - **SYMMETRY** implements symmetric correction for each pair of left and right speakers to flatten the frequency-amplitude characteristics.
  - **ALL CH ADJ** is a 'flat' setting where all the speakers are set individually so no special weighting is given to any one channel.
  - **FRONT ALIGN** sets all speakers in accordance with the front speaker settings (no equalization is applied to the front left and right channels).

If you selected **ALL** or **Keep SP System** as your **Auto MCACC** menu, you can specify the MCACC preset where you want to save the **SYMMETRY**, **ALL CH ADJ** and **FRONT ALIGN** settings.

EQ of subwoofer is automatically set when in **ALL CH ADJ** mode.

- **STAND.WAVE Multi-Point** (only available when the **Auto MCACC** Menu above is **EQ Pro & S-Wave**) – In addition to measurements at the listening position, you can use two more reference points for which test tones will be analyzed for standing waves. This is useful if you want to get a balanced 'flat' calibration for several seating positions in your listening area. Place the microphone at the reference point indicated on-screen and note that the last microphone placement will be at your main listening position:

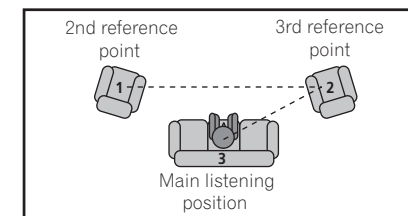

### 3 Connect the microphone to the MCACC SETUP MIC jack on the front panel.

Make sure there are no obstacles between the speakers and the microphone.

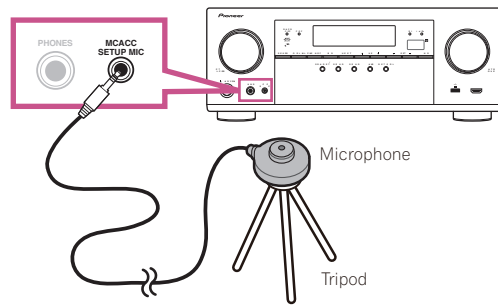

If you have a tripod, use it to place the microphone so that it's about ear level at your normal listening position. If you do not have a tripod, use some other object to install the microphone.

- It may not be possible to measure correctly if the microphone is placed on a table, sofa, etc.

### 4 When you're finished setting the options, select START then press ENTER.

### 5 Follow the instructions on-screen.

### 6 Wait for the Auto MCACC Setup to finish outputting test tones.

A progress report is displayed on-screen while the receiver outputs test tones to determine the speakers present in your setup. Try to be as quiet as possible while it's doing this.

- With error messages (such as **Too much ambient noise!** or **Check microphone.**), select **RETRY** after checking for ambient noise (see [Problems when using the Auto MCACC Setup](#) on [page 39](#)) and verifying the mic connection. If there doesn't seem to be a problem, you can simply select **GO NEXT** and continue.
- Do not adjust the volume during the test tones. This may result in incorrect speaker settings.

### 7 If necessary, confirm the speaker configuration in the GUI screen.

The configuration shown on-screen should reflect the actual speakers you have.

If no operations are performed for 10 seconds while the speaker configuration check screen is being displayed, the Auto MCACC Setup will resume automatically. In this case, you don't need to select **'OK'** and press **ENTER** in step 8.

- If you see an **ERR** message (or the speaker configuration displayed isn't correct), there may be a problem with the speaker connection. If selecting **RETRY** doesn't work, turn off the power and check the speaker connections. If there doesn't seem to be a problem, you can simply use **↑/↓** to select the speaker and **←/→** to change the setting and continue.
- If the speaker is not pointed to the microphone (listening position) or when using speakers that affect the phase (dipole speakers, reflective speakers, etc.), **Reverse Phase** may be displayed even if the speakers are properly connected.

If **Reverse Phase** is displayed, the speaker's wiring (+ and -) may be inverted. Check the speaker connections.

- If the connections were wrong, turn off the power, disconnect the power cord, then reconnect properly. After this, perform the Auto MCACC procedure again.
- If the connections were right, select **GO NEXT** and continue.

### 8 Make sure 'OK' is selected, then press ENTER.

A progress report is displayed on-screen while the receiver outputs more test tones to determine the optimum receiver settings.

Again, try to be as quiet as possible while this is happening. It may take 3 to 7 minutes.

- If you selected a **STAND.WAVE Multi-Point** setup (in step 2), you will be asked to place the mic at the 2nd and 3rd reference points before finally placing it at your main listening position.

### 9 The Auto MCACC Setup procedure is completed and the Advanced MCACC menu reappears automatically.

The settings made in the Auto MCACC Setup should give you excellent surround sound from your system, but it is also possible to adjust these settings manually using the **Manual MCACC** setup menu (starting below) or **Manual SP Setup** menu (starting on [page 89](#)).

- Depending on the characteristics of your room, sometimes identical speakers with cone sizes of around 12 cm (5 inches) will end up with different size settings. You can correct the setting manually using the [Manual speaker setup](#) on [page 89](#).
- The subwoofer distance setting may be farther than the actual distance from the listening position. This setting should be accurate (taking delay and room characteristics into account) and generally does not need to be changed.
- If Auto MCACC Setup measurement results are incorrect due to the interaction of the speakers and viewing environment, we recommend adjusting the settings manually.

You can also choose to view the settings by selecting individual parameters from the **MCACC Data Check** screen (see [Checking MCACC Data](#) on [page 86](#)).

Press **RETURN** after you have finished checking each screen. When you're finished, select **RETURN** to go back to the **HOME MENU**.

Be sure to disconnect the microphone from this receiver upon completion of the Auto MCACC Setup.



## Manual MCACC setup

You can use the settings in the **Manual MCACC** setup menu to make detailed adjustments when you're more familiar with the system. Before making these settings, you should have already completed [Automatically conducting optimum sound tuning \(Full Auto MCACC\)](#) on [page 38](#).

You only need to make these settings once (unless you change the placement of your current speaker system or add new speakers).



### CAUTION

- The test tones used in the **Manual MCACC** setup are output at high volume.



### Important

- Press the **MCACC** button while the pertinent setup screens are displayed to select MCACC presets.
- For some of the settings below, you'll have to connect the setup microphone to the front panel and place it about ear level at your normal listening position. Press **HOME MENU** to display the **HOME MENU** before you connect the microphone to this receiver.
- See [Problems when using the Auto MCACC Setup](#) on [page 39](#) for notes regarding high background noise levels and other possible interference.
- If you're using a subwoofer, switch it on and turn up the volume to the middle position.

#### 1 Select 'Manual MCACC' from the Advanced MCACC menu.

See [Making receiver settings from the Advanced MCACC menu](#) on [page 82](#) if you're not already at this screen.

#### 2 Select the setting you want to adjust.

If you're doing this for the first time, you might want to make these settings in order.

- Fine Channel Level** – Make fine adjustments to the overall balance of your speaker system (see [Fine Channel Level](#) on [page 84](#)).
- Fine SP Distance** – Make precise delay settings for your speaker system (see [Fine Speaker Distance](#) on [page 84](#)).
- Standing Wave** – Control overly resonant low frequencies in your listening room (see [Standing Wave](#) on [page 85](#)).

The last two settings are specifically for customizing the parameters explained in [Acoustic Calibration EQ Adjust](#) on [page 85](#):

- EQ Adjust** – Manually adjust the frequency balance of your speaker system while listening to test tones (see [Acoustic Calibration EQ Adjust](#) on [page 85](#)).
- EQ Professional** – Calibrate your system based on the direct sound coming from the speakers and make detailed settings according to your room's reverb characteristics (see [Acoustic Calibration EQ Professional](#) on [page 85](#)).

## Fine Channel Level

- Default setting: **0.0dB** (all channels)

You can achieve better surround sound by properly adjusting the overall balance of your speaker system. You can adjust the Channel Level of each speaker in 0.5 dB increments. The following setting can help you make detailed adjustments that you may not achieve using the [Manual speaker setup](#) on [page 89](#).

#### 1 Select 'Fine Channel Level' from the Manual MCACC setup menu.

The volume increases to the 0.0 dB reference level.

#### 2 Adjust the level of the left channel.

This will be the reference speaker level, so you may want to keep the level around **0.0dB** so that you'll have plenty of room to adjust the other speaker levels.

- After pressing **ENTER**, test tones will be output.

#### 3 Select each channel in turn and adjust the levels (+/-12.0 dB) as necessary.

Use **←/→** to adjust the volume of the speaker you selected to match the reference speaker. When it sounds like both tones are the same volume, press **↓** to confirm and continue to the next channel.

- For comparison purposes, the reference speaker will change depending on which speaker you select.
- If you want to go back and adjust a channel, simply use **↑/↓** to select it.

#### 4 When you're finished, press RETURN.

You will return to the **Manual MCACC** setup menu.

## Fine Speaker Distance

- Default setting: **10'00"** (all speakers)

For proper sound depth and separation with your system, it is necessary to add a slight bit of delay to some speakers so that all sounds will arrive at the listening position at the same time. You can adjust the distance of each speaker in half inch increments. The following setting can help you make detailed adjustments that you may not achieve using the [Manual speaker setup](#) on [page 89](#).

#### 1 Select 'Fine SP Distance' from the Manual MCACC setup menu.

#### 2 Adjust the distance of the left channel from the listening position.

#### 3 Select each channel in turn and adjust the distance as necessary.

Use **←/→** to adjust the delay of the speaker you selected to match the reference speaker.

Listen to the reference speaker and use it to measure the target channel. From the listening position, face the two speakers with your arms outstretched pointing at each speaker. Try to make the two tones sound as if they are arriving simultaneously at a position slightly in front of you and between your arm span.

- If you can't seem to achieve this by adjusting the distance setting, you may need to change the angle of your speakers very slightly.
- The subwoofer's test tone differs in tone from other channels. Adjust so that the sound of the subwoofer can be heard distinctly. Note that when adjusting the subwoofer, depending on the low frequency response of your speaker, it may be difficult to hear the change even when the setting is increased or decreased or when the position of the speaker is changed. Note that it may be difficult to compare this tone with the other speakers in your setup (depending on the low frequency response of the reference speaker).

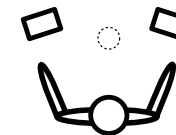

When it sounds like the delay settings are matched up, press **↓** to confirm and continue to the next channel.

- For comparison purposes, the reference speaker will change depending on which speaker you select.
- If you want to go back and adjust a channel, simply use **↑/↓** to select it.

#### 4 When you're finished, press RETURN.

You will return to the **Manual MCACC** setup menu.



## Standing Wave

- Default setting: **ON/ATT 0.0dB** (all filters)

Acoustic standing waves occur when, under certain conditions, sound waves from your speaker system resonate mutually with sound waves reflected off the walls in your listening area. This can have a negative effect on the overall sound, especially at certain lower frequencies. Depending on speaker placement, your listening position, and ultimately the shape of your room, it results in an overly resonant ('boomy') sound. The Standing Wave Control uses filters to reduce the effect of overly resonant sounds in your listening area. During playback of a source, you can customize the filters used for Standing Wave Control for each of your MCACC presets.

- Standing Wave control filter settings cannot be changed during playback of sources using the HDMI connection.

### 1 Select 'Standing Wave' from the Manual MCACC setup menu.

### 2 Adjust the parameters for the Standing Wave Control.

- **Filter Channel** – Select the channel to which you will apply the filter(s): **MAIN** (all except center channel and subwoofer), **Center** or **SW** (subwoofer).
- **TRIM** (only available when the filter channel above is **SW**) – Adjust the subwoofer channel level (to compensate for the difference in output post-filter).
- **Freq / Q / ATT** – These are the filter parameters where **Freq** represents the frequency you will be targeting and **Q** is the bandwidth (the higher the Q, the narrower the bandwidth, or range) of the attenuation (**ATT**, the amount of reduction to the targeted frequency).

### 3 When you're finished, press RETURN.

You will return to the **Manual MCACC** setup menu.

## Acoustic Calibration EQ Adjust

- Default setting: **ON/0.0dB** (all channels/bands)

Acoustic Calibration Equalization is a kind of room equalizer for your speakers (excluding the subwoofer). It works by measuring the acoustic characteristics of your room and neutralizing the ambient characteristics that can color the original source material (providing a 'flat' equalization setting). If you're not satisfied with the adjustment provided in [Automatically conducting optimum sound tuning \(Full Auto MCACC\)](#) on page 38 or [Automatic MCACC \(Expert\)](#) on page 82, you can also adjust these settings manually to get a frequency balance that suits your tastes.

### 1 Select 'EQ Adjust' from the Manual MCACC setup menu.

### 2 Select the channel(s) you want and adjust to your liking.

Use **↑/↓** to select the channel.

Use **←/→** to select the frequency and **↑/↓** to boost or cut the EQ. When you're finished, go back to the top of the screen and press **←** to return to **Ch**, then use **↑/↓** to select the channel.

- The **OVER!** indicator shows in the display if the frequency adjustment is too drastic and might distort. If this happens, bring the level down until **OVER!** disappears from the display.

### 3 When you're finished, press RETURN.

You will return to the **Manual MCACC** setup menu.



#### Notes

- Changing the frequency curve of one channel too drastically will affect the overall balance. If the speaker balance seems uneven, you can raise or lower channel levels using test tones with the **TRIM** feature. Use **←/→** to select **TRIM**, then use **↑/↓** to raise or lower the channel level for the current speaker.
- You cannot select **63Hz** for the channel, which is set to **SMALL** using **Speaker Setting**.
- The frequencies that can be adjusted by the **SW** channel are **31Hz**, **63Hz**, **125Hz** and **250Hz**.
- Depending on the crossover frequency setting, some frequencies are less effective.

## Acoustic Calibration EQ Professional

This setup minimizes the unwanted effects of room reverberation by allowing you to calibrate your system based on the direct sound coming from the speakers.

Performing the Acoustic Calibration EQ Professional procedure is effective when the lower frequencies seem overly reverberant in your listening room (i.e. it sounds 'boomy') as shown at Type A below, or when different channels seem to exhibit different reverb characteristics as shown at Type B.

### • Type A: Reverberance of high vs. low frequencies

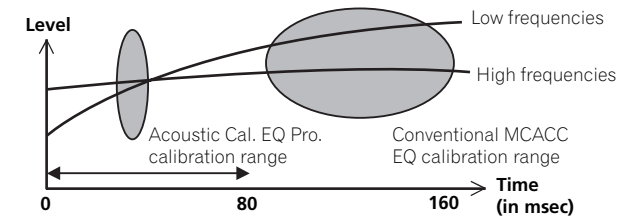

### • Type B: Reverb characteristics for different channels

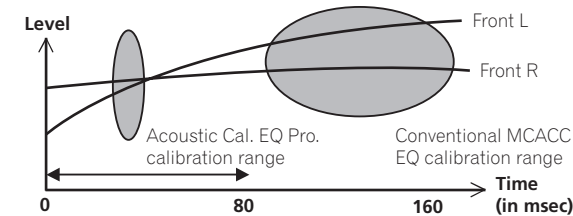

## Using Acoustic Calibration EQ Professional

### 1 Select 'EQ Professional', then press ENTER.

### 2 Select an option and press ENTER.

- **Reverb Measurement** – Use this to measure the reverb characteristics before and after calibration.
- **Reverb View** – You can check the reverb measurements made for specified frequency ranges in each channel.
  - If the **Reverb View** procedure is performed after the **Reverb Measurement** operation, depending on the standing wave control setting, differences may appear on the reverb graph. With the **Auto MCACC** function, the reverberations are measured with the standing waves controlled, so the reverb characteristics graph shows the characteristics with the effect of the standing waves eliminated. By contrast, the **Reverb Measurement** function measures the reverberations without controlling the standing waves, so the graph indicates the reverb characteristics including the effect of the standing waves. If you wish to check the reverb characteristics of the room itself (with the standing waves as such), we recommend using the **Reverb Measurement** function.
- **Advanced EQ Setup** – Use this to select the time period that will be used for frequency adjustment and calibration, based on the reverb measurement of your listening area. Note that customizing system calibration using this setup will alter the settings you made in [Automatically conducting optimum sound tuning \(Full Auto MCACC\)](#) on page 38 or [Automatic MCACC \(Expert\)](#) on page 82 and is not necessary if you're satisfied with these settings.



### 3 If you selected 'Reverb Measurement', select EQ ON or EQ OFF, and then START.

The following options determine how the reverb characteristics of your listening area are displayed in

#### Reverb View:

- **EQ OFF** – You will see the reverb characteristics of your listening area without the equalization performed by this receiver (before calibration).
- **EQ ON** – You will see the reverb characteristics of your listening area with the equalization performed by this receiver (after calibration). Note that the EQ response may not appear entirely flat due to adjustments necessary for your listening area.
  - The calibration corresponding to the currently selected MCACC preset will be used when **EQ ON** is selected. To use another MCACC preset, press **MCACC** to select the MCACC memory you want to store.
  - After auto calibration with **EQ Type : SYMMETRY (Full Auto MCACC, etc.)**, the graph for the inferred reverb characteristics can be displayed by selecting **Reverb View**. To display the actually measured reverb characteristics after EQ calibration, measure with **EQ ON**.

When the reverb measurement is finished, you can select **Reverb View** to see the results on-screen. See [Professional Calibration EQ graphical output](#) on [page 101](#) for troubleshooting information.

### 4 If you selected 'Reverb View', you can check the reverb characteristics for each channel. Press RETURN when you're done.

The reverb characteristics are displayed when the **Reverb Measurement** measurements are conducted. Use **←/→** to select the channel, frequency and calibration setting you want to check. Use **↑/↓** to go back and forth between the three. The reverb characteristics graph before and after EQ calibration can be displayed by selecting **Calibration : Before / After**. Note that the markers on the vertical axis indicate decibels in 2 dB steps.

### 5 If 'Advanced EQ Setup' is selected, select the MCACC memory to be stored, then enter the desired time setting for calibration, and then select START.

- To specify the place where the MCACC memory is to be stored, press **MCACC** to select the MCACC memory you want to store.

Based on the reverb measurement above, you can choose the time period that will be used for the final frequency adjustment and calibration. Even though you can make this setting without reverb measurement, it is best to use the measurement results as a reference for your time setting. For an optimal system calibration based on the direct sound coming from the speakers, we recommend using the **30-50ms** setting.

Use **←/→** to select the setting. Use **↑/↓** to switch between them.

Select the setting from the following time periods (in milliseconds): **0-20ms, 10-30ms, 20-40ms, 30-50ms, 40-60ms, 50-70ms** and **60-80ms**. This setting will be applied to all channels during calibration.

When you're finished, select **START**. It will take about 2 to 4 minutes for the calibration to finish.

After the Acoustic Calibration Equalization is set, you are given the option to check the settings on-screen.

## Checking MCACC Data

At the procedure of [Automatically conducting optimum sound tuning \(Full Auto MCACC\)](#) on [page 38](#), the procedure of [Automatic MCACC \(Expert\)](#) on [page 82](#) or after fine-adjusting at [Manual MCACC setup](#) on [page 84](#), you can check your calibrated settings using the GUI screen.

### 1 Press MAIN RECEIVER to the receiver operation mode, then press HOME MENU.

A Graphical User Interface (GUI) screen appears on your TV. Use **↑/↓/←/→** and **ENTER** to navigate through the screens and select menu items. Press **RETURN** to exit the current menu.

### 2 Select 'MCACC Data Check' from the HOME MENU.

### 3 Select the setting you want to check.

- **Speaker Setting** – Used to check the settings of the speaker systems. See [Speaker Setting](#) on [page 86](#) for more on this.
- **Channel Level** – Used to check the output level of the different speakers. See [Channel Level](#) on [page 86](#) for more on this.
- **Speaker Distance** – Used to check the distance to the different speakers. See [Speaker Distance](#) on [page 87](#) for more on this.
- **Standing Wave** – Used to check the standing wave control filter settings. See [Standing Wave](#) on [page 87](#) for more on this.
- **Acoustic Cal EQ** – Used to check the calibration values of the listening environment's frequency response. See [Acoustic Cal EQ](#) on [page 87](#) for more on this.

### 4 Press RETURN to go back to the MCACC Data Check menu, repeating steps 2 and 3 to check other settings.

### 5 When you're finished, press RETURN.

You will return to the **HOME MENU**.

## Speaker Setting

Use this to display the speaker size and number of speakers. See [Speaker Setting](#) on [page 89](#) for more on this.

### 1 Select 'Speaker Setting' from the MCACC Data Check menu.

### 2 Select the channel you want to check.

Use **↑/↓** to select the channel. The corresponding channel on the layout diagram is highlighted.

## Channel Level

Use this to display the level of the various channels. See [Channel Level](#) on [page 90](#) for more on this.

### 1 Select 'Channel Level' from the MCACC Data Check menu.

### 2 When 'MCACC' is highlighted, use ←/→ to select the MCACC preset you want to check.

The level of the various channels set at the selected MCACC preset is displayed. '---' is displayed for channels that are not connected.





## Speaker Distance

Use this to display the distance from the different channels to the listening position. See [Speaker Distance](#) on [page 90](#) for more on this.

- 1 Select 'Speaker Distance' from the MCACC Data Check menu.
- 2 When 'MCACC' is highlighted, use  $\leftarrow/\rightarrow$  to select the MCACC preset you want to check. The distance from the various channels set at the selected MCACC preset is displayed. '---' is displayed for channels that are not connected.

## Standing Wave

Use this to display the standing wave related adjustment values for the various MCACC memories. See [Standing Wave](#) on [page 85](#) for more on this.

- 1 Select 'Standing Wave' from the MCACC Data Check menu.
- 2 When 'Filter Channel' is highlighted, use  $\uparrow/\downarrow$  to select the channel for which you want to check standing wave control. The standing wave related calibration value for the selected channel stored at the selected MCACC preset and its graph are displayed.
- 3 Press  $\leftarrow$  to highlight 'MCACC', then use  $\uparrow/\downarrow$  to select the MCACC preset you want to check.

## Acoustic Cal EQ

Use this to display the calibration values for the frequency response of the various channels set in the different MCACC presets. See [Acoustic Calibration EQ Adjust](#) on [page 85](#) for more on this.

- 1 Select 'Acoustic Cal EQ' from the MCACC Data Check menu.
- 2 When 'Ch' is highlighted, use  $\uparrow/\downarrow$  to select the channel. The calibration value for the frequency response of the selected channel stored at the selected MCACC preset and its graph are displayed.
- 3 Press  $\leftarrow$  to highlight 'MCACC', then use  $\uparrow/\downarrow$  to select the MCACC preset you want to check.

## Data Management

This system allows you to store up to six MCACC presets, allowing you to calibrate your system for different listening positions (or frequency adjustments for the same listening position). This is useful for alternate settings to match the kind of source you're listening to and where you're sitting (for example, watching movies from a sofa, or playing a video game close to the TV).

From this menu you can copy from one preset to another, name presets for easier identification and clear any ones you don't need.

- This can be done in [Automatically conducting optimum sound tuning \(Full Auto MCACC\)](#) on [page 38](#) or [Automatic MCACC \(Expert\)](#) on [page 82](#), either of which you should have already completed.

- 1 Press MAIN RECEIVER to the receiver operation mode, then press HOME MENU. A Graphical User Interface (GUI) screen appears on your TV. Use  $\uparrow/\downarrow/\leftarrow/\rightarrow$  and ENTER to navigate through the screens and select menu items. Press RETURN to exit the current menu.
- 2 Select 'Data Management' from the HOME MENU.

### 3 Select the setting you want to adjust.

- **Memory Rename** – Name your MCACC presets for easy identification (see [Renaming MCACC presets](#) on [page 87](#)).
- **MCACC Memory Copy** – Copy settings from one MCACC preset to another (see [Copying MCACC preset data](#) on [page 87](#)).
- **MCACC Memory Clear** – Clear any MCACC presets that you don't want (see [Clearing MCACC presets](#) on [page 87](#)).

## Renaming MCACC presets

If you have several different MCACC presets that you're using, you may want to rename them for easier identification.

- 1 Select 'Memory Rename' from the Data Management setup menu.
- 2 Select the MCACC preset you want to rename, then select an appropriate preset name. Use  $\uparrow/\downarrow$  to select the preset, then  $\leftarrow/\rightarrow$  to select a preset name.
- 3 Repeat for as many MCACC presets as necessary, then press RETURN when you're finished. You will return to the Data Management setup menu.

## Copying MCACC preset data

If you want to manually adjust the Acoustic Calibration EQ (see [Manual MCACC setup](#) on [page 84](#)), we recommend copying your current settings to an unused MCACC preset. Instead of just a flat EQ curve, this will give you a reference point from which to start.

- The settings made in [Automatically conducting optimum sound tuning \(Full Auto MCACC\)](#) on [page 38](#) or [Automatic MCACC \(Expert\)](#) on [page 82](#).

- 1 Select 'MCACC Memory Copy' from the Data Management setup menu.
- 2 Select the setting you want to copy.
  - **All Data** – Copies all the settings of the selected MCACC preset memory.
  - **Level & Distance** – Copies only the channel level and speaker distance settings of the selected MCACC preset memory.
- 3 Select the MCACC preset you'll be copying the settings 'From', then specify where you want to copy them 'To'.

Make sure you don't overwrite an MCACC preset you're currently using (this can't be undone).

### 4 Select 'OK' to confirm and copy the settings.

When **MCACC Memory Copy?** is displayed, select YES. If NO is selected, the memory is not copied.

**Completed!** shows in the GUI screen to confirm the MCACC preset has been copied, then you automatically return to the Data Management setup menu.

## Clearing MCACC presets

If you are no longer using one of the MCACC presets stored in memory, you can choose to clear the calibration settings of that preset.

- 1 Select 'MCACC Memory Clear' from the Data Management setup menu.
- 2 Select the MCACC preset you want to clear. Make sure you don't clear an MCACC preset you're currently using (this can't be undone).
- 3 Select 'OK' to confirm and clear the preset.

When **MCACC Memory Clear?** is displayed, select YES. If NO is selected, the memory is not cleared.

**Completed!** shows in the GUI screen to confirm the MCACC preset has been cleared, then you automatically return to the Data Management setup menu.



## The System Setup and Other Setup menus

Making receiver settings from the System Setup menu .....	89
Manual speaker setup .....	89
Network Setup menu .....	91
Checking the Network Information .....	92
MHL Setup .....	92
The Other Setup menu .....	92
Making network settings using Safari .....	95
Using Safari to set a friendly name .....	95
Using Safari to update the firmware .....	96





## Making receiver settings from the System Setup menu



The following section describes how to change the speaker-related settings manually and make various other settings (input selection, OSD language selection, etc.).

- The OSD display is only displayed when the receiver's **HDMI OUT 1** terminal and the TV's HDMI input are connected with an HDMI cable. If the TV is connected with anything other than an HDMI cable, watch the front panel display while performing the various operations and making settings.

### 1 Press STANDBY/ON to switch on the receiver and your TV.

Make sure that the TV's video input is set to this receiver.

### 2 Press MAIN RECEIVER to the receiver operation mode, then press HOME MENU.

A Graphical User Interface (GUI) screen appears on your TV. Use /// and **ENTER** to navigate through the screens and select menu items. Press **RETURN** to exit the current menu.

- Press **HOME MENU** at any time to exit the **HOME MENU**.

### 3 Select 'System Setup' from the HOME MENU, then press ENTER.

### 4 Select the setting you want to adjust.

- **Manual SP Setup** – Sets the type of connection used for surround back terminals and the size, number distance and overall balance of the connected speakers (see [Manual speaker setup](#) on [page 89](#)).
- **Input Setup** – Specifies what you've connected to the digital, HDMI and component video inputs (see [The Input Setup menu](#) on [page 40](#)).
- **OSD Language** – The GUI screen's display language can be changed (see [Changing the OSD display language \(OSD Language\)](#) on [page 41](#)).
- **Network Setup** – Conducts the setup necessary to connect this unit to the network (see [Network Setup menu](#) on [page 91](#)).
- **HDMI Setup** – Synchronizes this receiver with your Pioneer component supporting **Control** with HDMI ([page 62](#)).
- **MHL Setup** – Changes the settings related to MHL (see [MHL Setup](#) on [page 92](#)).
- **Other Setup** – Makes customized settings to reflect how you are using the receiver (see [The Other Setup menu](#) on [page 92](#)).

## Manual speaker setup

This receiver allows you to make detailed settings to optimize the surround sound performance. You only need to make these settings once (unless you change the placement of your current speaker system or add new speakers).

These settings are designed to customize your system, but if you're satisfied with the settings made in [Automatically conducting optimum sound tuning \(Full Auto MCACC\)](#) on [page 38](#), it isn't necessary to make all of these settings.



### CAUTION

- The test tones used in the **Manual SP Setup** are output at high volume.

### 1 Select 'Manual SP Setup', then press ENTER.

See [Making receiver settings from the System Setup menu](#) on [page 89](#) if you're not already at this screen.

### 2 Select the setting you want to adjust.

If you are doing this for the first time, you may want to adjust these settings in order:

- **Speaker System** – Specifies how you are using your surround back speaker terminals and B speaker terminals ([page 89](#)).
- **Speaker Setting** – Specifies the size and number of speakers you've connected ([page 89](#)).
- **Channel Level** – Adjusts the overall balance of your speaker system ([page 90](#)).

- **Speaker Distance** – Specifies the distance of your speakers from the listening position ([page 90](#)).
- **X-Curve** – Adjusts the tonal balance of your speaker system for movie soundtracks ([page 90](#)).

### 3 Make the adjustments necessary for each setting, pressing RETURN to confirm after each screen.

## Speaker system setting

- Default setting: **Normal(SB/FH)**

There are several ways you can use the speaker terminals with this receiver. In addition to a normal home theater setup where they are used for the front height speakers or front wide speakers, they can be used for bi-amping the front speakers or as an independent speaker system in another room.

### 1 Select 'Speaker System' from the Manual SP Setup menu.

See [Making receiver settings from the System Setup menu](#) on [page 89](#) if you're not already at this screen.

### 2 Select the speaker system setting.

- **Normal(SB/FH)** – Select for normal home theater use with front height speakers in your main (speaker system A) setup.
- **Normal(SB/FW)** – Select for normal home theater use with front wide speakers in your main (speaker system A) setup.
- **Speaker B** – Select to use the B speaker terminals to listen to stereo playback in another room (see [Switching the speaker terminals](#) on [page 71](#)).
- **Front Bi-Amp** – Select this setting if you're bi-amping your front speakers (see [Bi-amping your speakers](#) on [page 22](#)).
- **ZONE 2** – Select to use the surround back speaker terminals for an independent system in another zone (see [Using the MULTI-ZONE controls](#) on [page 72](#)).
- **HDZONE** – Select to use the surround back speaker terminals for an independent system in HDZONE (see [Using the MULTI-ZONE controls](#) on [page 72](#)).

### 3 If you selected Normal(SB/FH), Normal(SB/FW), or Speaker B in Step 2, select the placement of the surround speakers.

In a 7.1-channel surround system with surround speakers placed directly at the sides of the listening position, the surround sound of 5.1-channel sources is heard from the side. This function mixes the sound of the surround speakers with the surround back speakers so that the surround sound is heard from diagonally to the rear as it should be.

Depending on the positions of the speakers and the sound source, in some cases it may not be possible to achieve good results. In this case, set the setting to **ON SIDE** or **IN REAR**.

- **ON SIDE** – Select when the surround speakers is positioned right beside you.
- **IN REAR** – Select when the surround speaker is positioned obliquely behind you.

### 4 When 'Setting Change?' is displayed, select Yes.

If **No** is selected, the setting is not changed.

You will return to the **Manual SP Setup** menu.

## Speaker Setting

Use this setting to specify your speaker configuration (size, number of speakers and crossover frequency). It is a good idea to make sure that the settings made in [Automatically conducting optimum sound tuning \(Full Auto MCACC\)](#) on [page 38](#) are correct. Note that this setting applies to all MCACC presets, and cannot be set independently.

### 1 Select 'Speaker Setting' from the Manual SP Setup menu.

### 2 Choose the set of speakers that you want to set, then select a speaker size.

Use / to select the size (and number) of each of the following speakers:



- **Front** – Select **LARGE** if your front speakers reproduce bass frequencies effectively, or if you didn't connect a subwoofer. Select **SMALL** to send the bass frequencies to the subwoofer.
- **Center** – Select **LARGE** if your center speaker reproduces bass frequencies effectively, or select **SMALL** to send bass frequencies to the other speakers or subwoofer. If you didn't connect a center speaker, choose **NO** (the center channel is sent to the front speakers).
- **FH** – Select **LARGE** if your front height speakers reproduce bass frequencies effectively, or select **SMALL** to send bass frequencies to the other speakers or subwoofer. If you didn't connect front height speakers, choose **NO** (the front height channel is sent to the front speakers).
  - You can adjust this setting only when **Speaker System** setting is **Normal(SB/FH)**.
  - If the surround speakers are set to **NO**, this setting will automatically be set to **NO**.
- **FW** – Select **LARGE** if your front wide speakers reproduce bass frequencies effectively, or select **SMALL** to send bass frequencies to the other speakers or subwoofer. If you didn't connect front wide speakers, choose **NO** (the front wide channel is sent to the front speakers).
  - You can adjust this setting only when **Speaker System** setting is **Normal(SB/FW)**.
  - If the surround speakers are set to **NO**, this setting will automatically be set to **NO**.
- **Surr** – Select **LARGE** if your surround speakers reproduce bass frequencies effectively. Select **SMALL** to send bass frequencies to the other speakers or subwoofer. If you didn't connect surround speakers choose **NO** (the sound of the surround channels is sent to the front speakers or a subwoofer).
- **SB** – Select the number of surround back speakers you have (one, two or none). Select **LARGE<sub>x2</sub>** or **LARGE<sub>x1</sub>** if your surround back speakers reproduce bass frequencies effectively. Select **SMALL<sub>x2</sub>** or **SMALL<sub>x1</sub>** to send bass frequencies to the other speakers or subwoofer. If you didn't connect surround back speakers choose **NO**.
  - If you selected **HDZONE**, **ZONE 2** or **Front Bi-Amp** (in [Speaker system setting](#) on [page 89](#)) you can't adjust the surround back settings.
  - If the surround speakers are set to **NO**, the surround back speakers will automatically be set to **NO**.
- **SW** – LFE signals and bass frequencies of channels set to **SMALL** are output from the subwoofer when **YES** is selected. Choose the **PLUS** setting if you want the subwoofer to output bass sound continuously or you want deeper bass (the bass frequencies that would normally come out the front and center speakers are also routed to the subwoofer). If you did not connect a subwoofer choose **NO** (the bass frequencies are output from other speakers).
  - If you have a subwoofer and like lots of bass, it may seem logical to select **LARGE** for your front speakers and **PLUS** for the subwoofer. This may not, however, yield the best bass results. Depending on the speaker placement of your room you may actually experience a decrease in the amount of bass due low frequency cancellations. In this case, try changing the position or direction of speakers. If you can't get good results, listen to the bass response with it set to **PLUS** and **YES** or the front speakers set to **LARGE** and **SMALL** alternatively and let your ears judge which sounds best. If you're having problems, the easiest option is to route all the bass sounds to the subwoofer by selecting **SMALL** for the front speakers.

If you select **NO** for the subwoofer the front speakers will automatically be fixed to **LARGE**. Also, the center, surround, surround back, front height and front wide speakers can't be set to **LARGE** if the front speakers are set to **SMALL**. In this case, all bass frequencies are sent to the subwoofer.

### 3 Select 'X. OVER' and set the crossover frequency.

Frequencies below this point will be sent to the subwoofer (or **LARGE** speakers).

- This setting decides the cutoff between bass sounds playing back from the speakers selected as **LARGE**, or the subwoofer, and bass sounds playing back from those selected as **SMALL**. It also decides where the cutoff will be for bass sounds in the LFE channel.
- With **Full Auto MCACC** setup or **Auto MCACC** setup (**ALL** or **Speaker Setting**), the setting here will not apply and the crossover frequency will be automatically set. Crossover frequency is a frequency aimed at achieving the optimal sound field taking into account the bass capacity of all connected speakers and human aural characteristics.

### 4 When you're finished, press RETURN.

You will return to the **Manual SP Setup** menu.

## Channel Level

Using the channel level settings, you can adjust the overall balance of your speaker system, an important factor when setting up a home theater system.

### 1 Select 'Channel Level' from the Manual SP Setup menu.

The test tones will start.

### 2 Adjust the level of each channel using ←/→.

Use ↑/↓ to switch speakers.

Adjust the level of each speaker as the test tone is emitted.

- If you are using a Sound Pressure Level (SPL) meter, take the readings from your main listening position and adjust the level of each speaker to 75 dB SPL (C-weighting/slow reading).

### 3 When you're finished, press RETURN.

You will return to the **Manual SP Setup** menu.

## Speaker Distance

For good sound depth and separation from your system, you need to specify the distance of your speakers from the listening position. The receiver can then add the proper delay needed for effective surround sound.

### 1 Select 'Speaker Distance' from the Manual SP Setup menu.

### 2 Adjust the distance of each speaker using ←/→.

You can adjust the distance of each speaker in 1/2 inch Increments.

### 3 When you're finished, press RETURN.

You will return to the **Manual SP Setup** menu.



#### Note

For best surround sound, make sure the surround back speakers are the same distance from the listening position.

## X-Curve

Most soundtracks mixed for cinema sound too bright when played back in large rooms. The X-Curve setting acts as a kind of re-equalization for home theater listening, and restores proper tonal balance of movie soundtracks.

### 1 Select 'X-Curve' from the Manual SP Setup menu.

### 2 Choose the X-Curve setting you want.

Use ←/→ to adjust the setting. The X-Curve is expressed as a downwards slope in decibels per octave, starting at 2 kHz. The sound becomes less bright as the slope increases (to a maximum of **-3.0dB/oct**). Use the following guidelines to set the X-Curve according to your room size:

Room size (ft <sup>2</sup> )	≤400	≤550	≤650	≤800	≤3200	≤12000
X Curve (dB/oct)	0.5	1.0	1.5	2.0	2.5	3.0

- If you select **OFF**, the frequency curve will be flat and the X-Curve has no effect.

### 3 When you're finished, press RETURN.



## Network Setup menu

Make the settings for connecting the receiver to the Internet and using the network functions.

### 1 Press MAIN RECEIVER to the receiver operation mode, then press HOME MENU.

A Graphical User Interface (GUI) screen appears on your TV. Use **↑/↓/←/→** and **ENTER** to navigate through the screens and select menu items. Press **RETURN** to exit the current menu.

### 2 Select 'System Setup' from the HOME MENU.

### 3 Select 'Network Setup' from the System Setup menu.

### 4 Select the setting you want to adjust.

If you are doing this for the first time, you may want to adjust these settings in order:

- **IP Address, Proxy** – Sets up the IP address/Proxy of this receiver ([page 91](#)).
- **Network Standby** – Allows the AVNavigator function to be used even when the receiver is in the standby mode ([page 91](#)).
- **Friendly Name** – The name of the receiver displayed on a computer or other device connected to the network can be changed ([page 91](#)).
- **Parental Lock** – Restricts usage of network functions ([page 92](#)).

## IP address/Proxy setting

In case the router connected to the LAN terminal on this receiver is a broadband router (with a built-in DHCP server function), simply turn on the DHCP server function, and you will not need to set up the network manually. You must set up the network as described below only when you have connected this receiver to a broadband router without a DHCP server function. Before you set up the network, consult with your ISP or the network manager for the required settings. It is advised that you also refer to the operation manual supplied with your network component.

- In case you make changes to the network configuration without the DHCP server function, make the corresponding changes to the network settings of this receiver.

### IP Address

The IP address to be entered must be defined within the following ranges. If the IP address defined is beyond the following ranges, you cannot play back audio files stored on components on the network or listen to Internet radio stations.

Class A: 10.0.0.1 to 10.255.255.254

Class B: 172.16.0.1 to 172.31.255.254

Class C: 192.168.0.1 to 192.168.255.254

### Subnet Mask

In case an xDSL modem or a terminal adapter is directly connected to this receiver, enter the subnet mask provided by your ISP on paper. In most cases, enter 255.255.255.0.

### Default Gateway

In case a gateway (router) is connected to this receiver, enter the corresponding IP address.

### Primary DNS Server/Secondary DNS Server

In case there is only one DNS server address provided by your ISP on paper, enter it in the '**Primary DNS Server**' field. In case there are more than two DNS server addresses, enter '**Secondary DNS Server**' in the other DNS server address field.

## Proxy Hostname/Proxy Port

This setting is required when you connect this receiver to the Internet via a proxy server. Enter the IP address of your proxy server in the '**Proxy Hostname**' field. Also, enter the port number of your proxy server in the '**Proxy Port**' field.

### 1 Select 'IP Address, Proxy' from the Network Setup menu.

### 2 Select the DHCP setting you want.

When you select **ON**, the network is automatically set up, and you do not need to follow Steps 3. Proceed with Step 4.

If there is no DHCP server on the network and you select **ON**, this receiver will use its own Auto IP function to determine the IP address.

- The IP address determined by the Auto IP function is 169.254.X.X. You cannot listen to an Internet radio station if the IP address is set for the Auto IP function.

### 3 Enter the IP Address, Subnet Mask, Default Gateway, Primary DNS Server and Secondary DNS Server.

Press **↑/↓** to select a number and **←/→** to move the cursor.

### 4 Select 'OFF' or 'ON' for the Enable Proxy Server setting to deactivate or activate the proxy server.

In case you select '**OFF**', proceed with Step 7. In case you select '**ON**', on the other hand, proceed with Step 5.

### 5 Enter the address of your proxy server or the domain name.

Use **↑/↓** to select a character, **←/→** to set the position, and **ENTER** to confirm your selection.

### 6 Enter the port number of your proxy server.

Use **↑/↓** to select a character, **←/→** to set the position, and **ENTER** to confirm your selection.

### 7 Select 'OK' to confirm the IP Address/Proxy setup.

## Network Standby

This setting allows the AVNavigator function for operating the receiver from a computer connected on the same LAN as the receiver to be used even when the receiver is in the standby mode.

### 1 Select 'Network Standby' from the Network Setup menu.

### 2 Specify whether the Network Standby is ON or OFF.

- **ON**: Even when the receiver is in standby mode, the power can be turned on from an external application (iControlAV5, etc.) on a device connected to the network.
- **OFF** – The AVNavigator function cannot be used when the receiver is in the standby mode (This lets you reduce power consumption in the standby mode).

## Friendly Name

### 1 Select 'Friendly Name' from the Network Setup menu.

### 2 Select 'Edit Name' then select 'Rename'.

If after changing the name you want to restore the name to the default, select **Default**.

### 3 Input the name you want.

Use **↑/↓** to select a character, **←/→** to set the position, and **ENTER** to confirm your selection.



## Parental Lock

Set restrictions for using Internet services. Also set the password accompanying the usage restrictions.

- Upon shipment from the factory, the password is set to "0000".



### Important

When the **INTERNET RADIO**, **PANDORA** or **FAVORITES** input is selected, the setting made here cannot be reflected.

**1 Select 'Parental Lock' from the Network Setup menu.**

**2 Input the password.**

Use **↑/↓** to select a character, **←/→** to set the position, and **ENTER** to confirm your selection.

**3 Specify whether to turn Parental Lock on or off.**

- **OFF** – Internet services are not restricted.
- **ON** – Internet services are restricted.

**4 If you want to change the password, select Change Password.**

In this case, the procedure returns to step 2.

## Checking the Network Information

The setting status of the following network-related items can be checked.

- **IP Address** – Check the IP address of this receiver.
- **MAC Address** – Check the MAC address of this receiver.
- **Friendly Name** – [Friendly Name](#) on [page 91](#).

**1 Press MAIN RECEIVER to the receiver operation mode, then press HOME MENU.** A Graphical User Interface (GUI) screen appears on your TV. Use **↑/↓** and **ENTER** to navigate through the screens and select menu items. Press **RETURN** to exit the current menu.

**2 Select 'Network Information' from the HOME MENU.**

Display the setting status of the network-related items.

## MHL Setup

**1 Press MAIN RECEIVER to the receiver operation mode, then press HOME MENU.**

A Graphical User Interface (GUI) screen appears on your TV. Use **↑/↓/←/→** and **ENTER** to navigate through the screens and select menu items. Press **RETURN** to exit the current menu.

- Press **HOME MENU** at any time to exit the **HOME MENU**.

**2 Select 'System Setup' from the HOME MENU, then press ENTER.**

**3 Select 'MHL Setup' from the System Setup menu.**

**4 Select the setting you want to adjust.**

If you are doing this for the first time, you may want to adjust these settings in order:

- **Auto input switching** – Select whether or not to switch the input automatically to the **MHL** input when an MHL-compatible device is connected ([page 92](#)).
- **ROKU Standby Mode** – Set ROKU standby mode ([page 92](#)).

**5 Select 'OK', then press ENTER.**

## Auto input switching

Select whether or not to switch the input automatically to the **MHL** input when an MHL-compatible device is connected.

- Default setting: **ON**

**1 Select the 'Auto input switching' from the MHL Setup menu.**

**2 Use ←/→ to select the setting.**

- **OFF** – Does not automatically switch to **MHL** input.
- **ON** – Automatically switches to **MHL** input.



### Notes

- This is only valid for MHL-compatible devices supporting this function.
- When the power is on, the MHL-compatible device is charged. (This receiver supports charging of devices up to 0.9 A.)

## ROKU standby mode

**1 Select the 'ROKU Standby Mode' from the MHL Setup menu.**

**2 Use ←/→ to select the setting.**

- **OFF** – When the receiver is in the standby mode, power is not provided to the Roku Streaming Stick. Energy consumption will decrease but it will take approximately 90 seconds for the images to be played back.
- **ON** – Will provide power to the Roku Streaming Stick even if the receiver is in the standby mode. Energy consumption will increase but will be able to immediately playback images. Power will be supplied even if a MHL device is connected.

## The Other Setup menu

The **Other Setup** menu is where you can make customized settings to reflect how you are using the receiver.

**1 Press MAIN RECEIVER to the receiver operation mode, then press HOME MENU.**

A Graphical User Interface (GUI) screen appears on your TV. Use **↑/↓/←/→** and **ENTER** to navigate through the screens and select menu items. Press **RETURN** to exit the current menu.

**2 Select 'System Setup' from the HOME MENU.**

**3 Select 'Other Setup', then press ENTER.**

**4 Select the setting you want to adjust.**

If you are doing this for the first time, you may want to adjust these settings in order:

- **Auto Power Down** – Sets the power to turn off automatically when the receiver is not being used ([page 93](#)).
- **Volume Setup** – Sets up the volume-related operations of this receiver ([page 93](#)).
- **Remote Control Mode Setup** – Sets this receiver's remote control mode ([page 93](#)).
- **Software Update** – Use to update the receiver's software and check the version ([page 93](#)).
- **ZONE Setup** – Use to make the sub zone-related settings ([page 94](#)).
- **On Screen Display Setup** – Sets whether or not to display the status on the display when the receiver is operated ([page 94](#)).
- **Play ZONE Setup** – Select the zone for playing the audio contents of devices in the home network ([page 94](#)).

**5 Make the adjustments necessary for each setting, pressing RETURN to confirm after each screen.**



## Auto Power Down

The power can be set to turn off automatically if no operation has been performed for a specific amount of time with no audio or video signals being input to the receiver. When using ZONE 2 or HDZONE, the ZONE 2 or HDZONE power can also be set to turn off, but for ZONE 2 or HDZONE the power turns off automatically after the amount of time set here even if signals are being input or operations have been performed.

Different times can be set for the main zone, ZONE 2 and HDZONE.

- 1 **Select 'Auto Power Down' from the Other Setup menu.**
- 2 **Select the zone you want to set and set the time after which the power turns off.**
  - **MAIN** – The time can be selected from among "15 min", "30 min", "60 min" and "OFF". The power turns off after there has been no signal and no operation for the selected time.
  - **ZONE 2** – The time can be selected from among "30 min", "1 hour", "3 hours", "6 hours", "9 hours" and "OFF". The power turns off after the selected time.
  - **HDZONE** – The time can be selected from among "30 min", "1 hour", "3 hours", "6 hours", "9 hours" and "OFF". The power turns off after the selected time.



### Note

Depending on the connected devices, the Auto Power Down function may not work properly due to excessive noise or other reasons.

## Volume Setup

You can set the maximum volume of this receiver or specify what the volume level will be when the power is turned on.

- 1 **Select 'Volume Setup' from the Other Setup menu.**
- 2 **Select the Power ON Level setting you want.**

The volume can be set so that it is always set to the same level when the receiver's power is turned on.

- **LAST** (default) – When the power is turned on, the volume is set to the same level as when the power was last turned off.
- **"---** – When the power is turned on, the volume is set to minimum level.
- **-80.0dB to +12.0dB** – Specify the volume to be set when the power is turned on, in steps of 0.5 dB.

It is not possible to set a volume level greater than the value specified at Volume Limit setup (see below).

- 3 **Select the Volume Limit setting you want.**

Use this function to limit the maximum volume. The volume cannot be increased above the level set here, even by operating **VOLUME** button (or the dial on the front panel).

- **OFF** (default) – The maximum volume is not limited.
- **-20.0dB/-15.0dB/-10.0dB/-5.0dB/0.0dB** – The maximum volume is limited to the value set here.

- 4 **Select the Mute Level setting you want.**

This sets how much the volume is to be turned down when **MUTE** is pressed.

- **FULL** (default) – No sound.
- **-40.0dB/-20.0dB** – The volume will be turned down to the level specified here.

- 5 **When you're finished, press RETURN.**

You will return to the **Other Setup** menu.

## Remote Control Mode Setup

- Default setting: **1**

This sets this receiver's remote control mode to prevent erroneous operation when multiple units of the receiver are being used.

- 1 **Select 'Remote Control Mode Setup' from the Other Setup menu.**
- 2 **Select the Remote Control Mode setting you want.**
- 3 **Select 'OK' to change the remote control mode.**
- 4 **Follow the instructions on the screen to change the remote control's setting.**  
See [Operating multiple receivers](#) on [page 76](#).
- 5 **When you're finished, press RETURN.**  
You will return to the **Other Setup** menu.

## Software Update

Use this procedure to update the receiver's software and check the version. There are two ways to update: via the Internet and via a USB memory device.

Updating via the Internet is performed by accessing the file server from the receiver and downloading the file. This procedure is only possible if the receiver is connected to the Internet.

Updating via a USB memory device is performed by downloading the update file from a computer, reading this file onto a USB memory device then inserting this USB memory device into the USB port on the receiver's front panel. With this procedure, the USB memory device containing the update file must first be inserted into the USB port on the receiver's front panel.

- If an update file is provided on the Pioneer website, download it onto your computer. When downloading an update file from the Pioneer website onto your computer, the file will be in ZIP format. Unzip the ZIP file before saving it on the USB memory device. If there are any old downloaded files or downloaded files for other models on the USB memory device, delete them.  
<http://www.pioneerelectronics.com>
- If an update file does not exist in the Pioneer's website, updating the software for the receiver is not necessary.



### Important

- DO NOT unplug the power cord during updating.
- When updating via the Internet, do not disconnect the LAN cable. When updating via a USB memory device, do not disconnect the USB memory device.
- If updating is interrupted before it is completed, start updating over from the beginning.
- The receiver's settings may be reset when the software is updated. Information on the models for which the settings are reset is provided on the Pioneer website. Check the website before updating.

- 1 **Select 'Software Update' from the Other Setup menu.**

- 2 **Select the update procedure.**

- **Update via Internet** – The receiver checks whether updatable software is available via the Internet.
- **Update via USB Memory** – The receiver checks whether the USB memory device inserted into the USB port on the receiver's front panel contains updatable software.  
"Accessing" is displayed and the update file is checked. Wait a while.

- 3 **Check on the screen whether or not an update file was found.**

If "**New version found.**" is displayed, the update file has been found. The version number and updating time are displayed.

If "**This is the latest version. There is no need to update.**" is displayed, no update file has been found.

- 4 **To update, select OK.**

The updating screen appears and updating is performed.

- The power turns off automatically once updating is completed.





## Software Update messages

Status messages	Descriptions
<b>FILE ERROR</b>	Try disconnecting then reconnecting the USB device or storing the update file again. If the error still occurs, try using a different USB memory device.
<b>UPDATE ERROR 1 to UPDATE ERROR 7</b>	No update file was found on the USB memory device. Store the file in the USB memory device's root directory.
<b>Update via USB</b>	Turn the receiver's power off, then turn it back on and try updating the software again.
<b>UE11</b>	If this message flashes, updating has failed. Update via a USB memory device. Put the update file on a USB memory device and connect the device to the USB port. When the file is found, software updating starts automatically.
<b>UE22</b>	Updating has failed. Use the same procedure to update the software again.
<b>UE33</b>	

## ZONE Setup

Switches the sub-zone setting.

### 1 Select 'ZONE Setup' from the Other Setup menu.

### 2 Select 'MAIN/HDZONE', then press ENTER.

### 3 Set the usage of the HDMI OUT 2 terminal.

- **MAIN:** Select this to output the same input source as in the main zone.

After setting this to **MAIN**, exit the home menu, then press **OUT P.** and select the terminal for HDMI output ([page 71](#)).

- **HDZONE:** Use the HDMI output's multizone function (**HDZONE**) to output an input source different from the one in the main zone ([page 72](#)).

### 4 When you're finished, press RETURN.

You will return to the **Other Setup** menu.

## ZONE 2 setup

When making multi-zone connections using the **AUDIO ZONE 2 OUT** terminals and performing playback in Zone 2, you can set whether to adjust the Zone 2 volume on the receiver or to fix it to a specific volume (**-40 dB Fixed** or **0 dB Fixed**). This is set to **Variable** upon shipment from the factory, allowing the volume to be adjusted on the receiver. If you would like to adjust the volume from the connected amplifier, make the setting below.

- This setting is not possible if multi-zone settings have been made using the speaker terminals and **Speaker System** is set to anything other than **ZONE 2**. In this case, adjust the volume for the sub zones on the receiver.



### CAUTION

- Note that when **Volume Level** is set to **0 dB Fixed**, the audio output from the **AUDIO ZONE 2 OUT** terminals is set to the maximum. Also, depending on the volume setting on the connected amplifier, large volumes may be produced even when **Volume Level** is set to **-40 dB Fixed**.

### 1 Select 'ZONE Setup' from the Other Setup menu.

### 2 Select 'ZONE 2', then press ENTER.

### 3 Select the Volume Level setting you want.

- **Variable** (default) – The Zone 2 volume is adjusted from the receiver.

- **-40 dB Fixed/0 dB Fixed** – The Zone 2 volume level output from the receiver is fixed to the value set here.

### 4 When you're finished, press RETURN.

You will return to the **Other Setup** menu.

## On Screen Display Setup

When the receiver is operated, its status (the input name, listening mode, etc.) is displayed superimposed over the video output on the display. This status display can be turned off by switching this setting to **OFF**. The setting can be made for the main zone and HDZONE, respectively.

- Default: **ON** (both the main zone and HDZONE)

### 1 Select 'On Screen Display Setup' from the Other Setup menu.

### 2 Select and set the main zone or HDZONE for which you wish to change the setting.

### 3 Select the On Screen Display setting you want.

### 4 When you're finished, press RETURN.

You will return to the **Other Setup** menu.



### Notes

- The on-screen display is only displayed for video output from the HDMI terminal.
- When the video input signal is a 3D signal, the on-screen display may not be displayed.
- The size of the characters displayed differs according to the output resolution.

## Play ZONE Setup

Select the zone for playing the audio contents of devices in the home network when using in the DMR mode.

- For playable DLNA-compatible network devices, see [page 56](#).

### 1 Select 'Play ZONE Setup' from the Other Setup menu.

### 2 Select the zone in which you want to play the audio contents.

### 3 When you're finished, press RETURN.

You will return to the **Other Setup** menu.



### Note

If another zone is on, it may not be possible to play the audio contents. In this case, turn the other zone off, then play the audio contents.



## Making network settings using Safari

- 1 Launch Safari on your computer.
- 2 Press Bookmark icon. Click Bonjour list (a), and then select this receiver's name (Friendly Name) (b) in Bookmark.

If Bonjour list is not displayed, access the IP address "http://(the receiver's IP address)" from Safari.

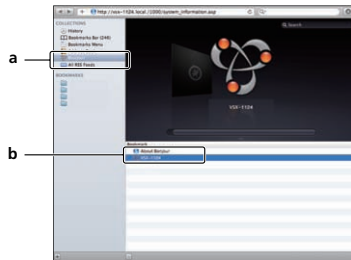

- 3 On the AVNavigator menu screen, select Network Setup.



- 4 Click IP, Proxy Setting.
- 5 Setup the network settings manually and then press Apply.

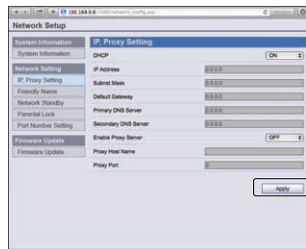

### Note

This setting for the network has been confirmed for Mac OS X 10.7 and Safari 5.1.

## Using Safari to set a friendly name

- 1 Launch Safari on your computer.
- 2 Press Bookmark icon. Click Bonjour list (a), and then select this receiver's name (Friendly Name) (b) in Bookmark.

If Bonjour list is not displayed, access the IP address "http://(the receiver's IP address)" from Safari.

- 3 On the AVNavigator menu screen, select Network Setup.
- 4 Click Friendly Name.
- 5 Input a friendly name, then press Apply.

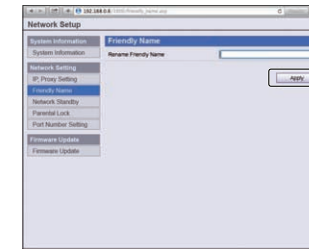

### Note

This setting for the network has been confirmed for Mac OS X 10.7 and Safari 5.1.



## Using Safari to update the firmware

- 1 Launch Safari on your computer.
- 2 Press Bookmark icon. Click Bonjour list (a), and then select this receiver's name (Friendly Name) (b) in Bookmark.  
If Bonjour list is not displayed, access the IP address "http://(the receiver's IP address)" from Safari.
- 3 On the AVNavigator menu screen, select Network Setup.
- 4 Click Firmware Update.

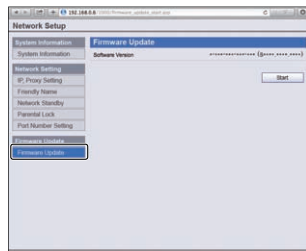

- 5 Press Start.

The firmware update prepare screen is displayed. If the screen does not switch automatically, click [Click here](#).

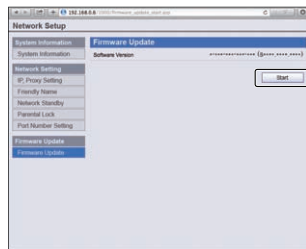

- 6 Browse the latest firmware on your computer (a) and then press Upload (b).

Firmware files have the extension "fw". Select a file with the extension "fw".

The confirmation screen is displayed. If you continue the firmware update, press **OK**. Once the firmware update process starts, you cannot stop it. Wait until the file is uploaded (about one minute may be required depending on your LAN connection environment).

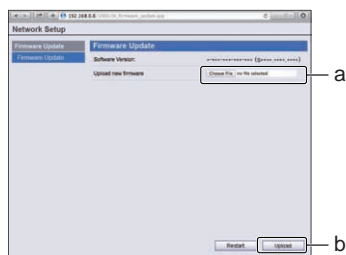

- 7 The firmware upload status screen is displayed.

"The upload process finished successfully." will be shown when the update is completed. Once updating is completed, the receiver's power automatically turns off.

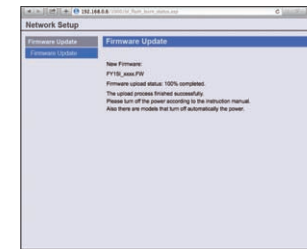

### Note

This setting for the network has been confirmed for Mac OS X 10.7 and Safari 5.1.





## FAQ

Troubleshooting .....	98
Power.....	98
No sound .....	98
Other audio problems .....	99
ADAPTER PORT terminal.....	100
Video.....	100
Settings.....	101
Professional Calibration EQ graphical output.....	101
Display .....	101
Remote control .....	102
HDMI.....	102
MHL.....	103
Built-in AVNavigator .....	103
USB interface.....	104
iPod .....	104
Network.....	104
Wireless LAN .....	107



## Troubleshooting

Incorrect operations are often mistaken for trouble and malfunctions. If you think that there is something wrong with this component, check the points below. Sometimes the trouble may lie in another component. Investigate the other components and electrical appliances being used. If the trouble cannot be rectified even after exercising the checks listed below, ask your nearest Pioneer authorized independent service company to carry out repair work.

- If the unit does not operate normally due to external effects such as static electricity disconnect the power plug from the outlet and insert again to return to normal operating conditions.

If the problem is not solved after the troubleshooting below, if the screen freezes unexpectedly or if the buttons on the remote control or front panel stop working completely, do the following:

- Press **⏻ STANDBY/ON** on the front panel to turn off the power, then turn the power back on.  
If this does not solve the problem, turn off the power again, then press and hold the **⏻ STANDBY/ON** button on the front panel for at least five seconds. (The power turns on, then turns off after five seconds.)
- If the power cannot be turned off, press and hold **⏻ STANDBY/ON** on the front panel for over five seconds. The power will turn off. In this case, the various settings made on the receiver may be cleared. (However, settings made when the power was turned off normally are not cleared.)

## Power

Symptom	Remedy
The power does not turn on.	Make sure that the power cord is plugged in to an active power outlet. Try disconnecting from the power outlet, then plugging back in.
Power cannot be turned off. ( <b>ZONE 2 ON</b> is displayed.)	Press the <b>ZONE 2</b> button on the remote control for 1.5 seconds and then press the <b>⏻ STANDBY/ON</b> button to turn OFF the power.
Power cannot be turned off. ( <b>HDZONE ON</b> is displayed.)	Press the <b>HDZONE</b> button on the remote control for 1.5 seconds and then press the <b>⏻ STANDBY/ON</b> button to turn OFF the power.
The receiver suddenly switches off or the <b>iPod iPhone</b> indicator blinks.	Check that there are no loose strands of speaker wire touching the rear panel or another set of wires. If so, re-attach the speaker wires, making sure there are no stray strands. The receiver may have a serious problem. Disconnect from the power and call a Pioneer authorized independent service company.
During loud playback the power suddenly switches off.	Turn down the volume. Lower the 63 Hz and 125 Hz equalizer levels in the <a href="#">Manual MCACC setup on page 84</a> . Switch on the digital safety feature. While holding down <b>ENTER</b> on the front panel, press <b>⏻ STANDBY/ON</b> to set this receiver to the standby mode. Use <b>TUNE ↑/↓</b> to select <b>D.SAFETY ◀OFF▶</b> , and then use <b>PRESET ←/→</b> to select <b>1</b> or <b>2</b> (select <b>D.SAFETY ◀OFF▶</b> to deactivate this feature). If the power switches off even with <b>2</b> switched on, turn down the volume. With <b>1</b> or <b>2</b> on, some features may be unavailable. If there is very little low frequency information in the source material, change your speaker settings to Front: <b>SMALL</b> / Subwoofer: <b>YES</b> , or Front: <b>LARGE</b> / Subwoofer: <b>PLUS</b> (see <a href="#">Speaker Setting on page 89</a> ).
The unit does not respond when the buttons are pressed.	Try switching the receiver off, then back on again. Try disconnecting the power cord, then connect again.
<b>AMP ERR</b> blinks in the display, then the power automatically switches off. The <b>ADVANCED MCACC</b> blinks and the power does not turn on.	The receiver may have a serious problem. Do not try switching the receiver on. Unplug the receiver from the wall and call a Pioneer authorized independent service company.

Symptom	Remedy
The receiver suddenly switches off or the <b>FL OFF</b> indicator blinks.	There is a possibility that the power supply circuit of the receiver has failed. Wait at least one minute and then turn ON the power again. If the same symptom appears again after turning ON the power again, stop using the receiver, disconnect the power cable and request repair.
<b>AMP OVERHEAT</b> blinks in the display and the <b>FL OFF</b> indicator flash and the power turns off.	Allow the unit to cool down in a well-ventilated place before switching back on (see <a href="#">Installing the receiver on page 10</a> ). Check whether the cables used to connect the speakers are short-circuited. Wait at least 1 minute, then try turning the power on again. The temperature within the unit has exceeded the allowable value. Lower the volume level.
<b>HDZONE</b> cannot be turned on.	Set <b>Output Setting</b> at <b>MAIN/HDZONE</b> to <b>HDZONE</b> ( <a href="#">page 94</a> ).

## No sound

Symptom	Remedy
No sound is output when an input function is selected. No sound is output from the front speakers.	Check the volume, mute setting (press <b>MUTE</b> ) and speaker setting (press <b>OUT P.</b> ). Make sure the correct input function is selected. Check that the MCACC setup microphone is disconnected. Make sure the correct input signal is selected (see <a href="#">Choosing the input signal on page 54</a> ). Note that when <b>Fixed PCM ON</b> is selected, you won't be able to hear any other signal format (see <a href="#">Setting the Audio options on page 67</a> ). Check that the source component is connected properly (see <a href="#">Connecting your equipment on page 18</a> ). Check that the speakers are connected properly (see <a href="#">Connecting the speakers on page 21</a> ).
No sound from the surround or center speakers.	Check that the Stereo listening mode or the Front Stage Surround Advance mode isn't selected; select one of the surround listening modes (see <a href="#">Enjoying various types of playback using the listening modes on page 52</a> ). Check that the surround/center speakers are not set to <b>NO</b> (see <a href="#">Speaker Setting on page 89</a> ). Check the channel level settings (see <a href="#">Channel Level on page 90</a> ). Check the speaker connections (see <a href="#">Connecting the speakers on page 21</a> ).
No sound from surround back speakers.	Check that the surround back speakers are set to <b>LARGE</b> or <b>SMALL</b> , and the surround speakers are not set to <b>NO</b> (see <a href="#">Speaker Setting on page 89</a> ). Check the speaker connections (see <a href="#">Connecting the speakers on page 21</a> ). If only one surround back speaker is connected, make sure it's connected to the left channel speaker terminal. Surround back speakers will not play while the <b>Speaker System</b> is set to <b>Speaker B</b> and audio is being played through speaker B. When <b>Speaker System</b> is set to <b>Normal(SB/FH)</b> or <b>Normal(SB/FW)</b> and <b>SP: FH ON</b> or <b>SP: FW ON</b> is selected with the <b>OUT P.</b> button, no sound will be output from the surround back speakers. Select <b>SP: SB/FH ON</b> , <b>SP: SB/FW ON</b> or <b>SP: SB ON</b> (see <a href="#">Switching the speaker terminals on page 71</a> ).



Symptom	Remedy
No sound from front height or front wide speakers.	<p>Check that the front height or front wide speakers are set to <b>LARGE</b> or <b>SMALL</b>, and the surround speakers are not set to <b>NO</b> (see <a href="#">Speaker Setting</a> on page 89).</p> <p>When <b>Speaker System</b> is set to <b>Normal(SB/FH)</b> or <b>Normal(SB/FW)</b> and <b>SP: SB ON</b> is selected with the <b>OUT P.</b> button, no sound will be output from the front height or front wide speakers. Select <b>SP: SB/FH ON</b>, <b>SP: SB/FW ON</b>, <b>SP: FH ON</b> or <b>SP: FW ON</b> (see <a href="#">Switching the speaker terminals</a> on page 71).</p> <p>Check the speaker connections (see <a href="#">Connecting the speakers</a> on page 21).</p>
No sound from subwoofer.	<p>Check that the subwoofer is connected properly, switched on and the volume turned up.</p> <p>If your subwoofer has a sleep function, make sure it is switched off.</p> <p>Make sure that the Subwoofer setting is <b>YES</b> or <b>PLUS</b> (see <a href="#">Speaker Setting</a> on page 89).</p> <p>The crossover frequency may be set too low; try setting it higher to match the characteristics of your other speakers (see <a href="#">Speaker Setting</a> on page 89).</p> <p>If there is very little low frequency information in the source material, change your speaker settings to Front: <b>SMALL</b> / Subwoofer: <b>YES</b>, or Front: <b>LARGE</b> / Subwoofer: <b>PLUS</b> (see <a href="#">Speaker Setting</a> on page 89).</p> <p>Check that the <b>LFE</b> channel is not set to <b>OFF</b>, or to a very quiet setting (see <a href="#">Setting the Audio options</a> on page 67).</p> <p>Check the speaker level settings (see <a href="#">Channel Level</a> on page 90).</p>
No sound from one speaker.	<p>Check the speaker connection (see <a href="#">Connecting the speakers</a> on page 21).</p> <p>Check the speaker level settings (see <a href="#">Channel Level</a> on page 90).</p> <p>Check that the speaker hasn't been set to <b>NO</b> (see <a href="#">Speaker Setting</a> on page 89).</p> <p>The channel may not be recorded in the source. By using one of the advanced effect listening modes, you may be able to create the missing channel (see <a href="#">Enjoying various types of playback using the listening modes</a> on page 52).</p>
Sound is produced from analog components, but not from digital ones (DVD, LD, CD, etc.).	<p>Check that the input signal type is set to <b>DIGITAL</b> (see <a href="#">Choosing the input signal</a> on page 54).</p> <p>Make sure that the digital input is assigned correctly for the input jack the component is connected to (see <a href="#">The Input Setup menu</a> on page 40).</p> <p>Check the digital output settings on the source component.</p> <p>If the source component has a digital volume control, make sure this is not turned down.</p>
No sound is output or a noise is output when Dolby Digital/DTS software is played back.	<p>Check that your BD or DVD player is compatible with Dolby Digital/DTS discs.</p> <p>Check the digital output settings or the HDMI audio output settings of your BD or DVD player. Make sure that the DTS signal output is set to On.</p> <p>If the source component has a digital volume control, make sure this is not turned down.</p>
No sound when using the <b>HOME MENU</b> .	<p>If the HDMI input function is selected, sound is muted until exiting the <b>HOME MENU</b>.</p>

## Other audio problems

Symptom	Remedy
Speaker switching sound (clicking sound) is heard from receiver during playback.	<p>Since <b>ECO MODE 1</b> and <b>ECO MODE 2</b> reduce the power consumption, the speakers are switched in function of the number of input channels. Because of this, a speaker switching sound (clicking sound) may be produced when the number of input channels is switched. If this bothers you, switch to a different listening mode.</p> <p>Depending on the listening mode, the front height (or front wide) and surround back speakers may switch automatically in function of changes in the input audio. A speaker switching sound (clicking sound) will be heard from the receiver at this time. If this sound bothers you, we recommend to change the speaker terminal option (see <a href="#">Switching the speaker terminals</a> on page 71).</p>
Broadcast stations cannot be selected automatically, or there is considerable noise in radio broadcasts.	<p>Fully extend the FM wire antenna, adjust the position for best reception and secure to a wall, etc.</p> <p>Use an outdoor antenna for better reception (see <a href="#">page 30</a>).</p> <p>Adjust the position and direction of the AM antenna.</p> <p>Noise may be caused by interference from other equipment, such as a fluorescent light, motor, etc. Switch off or move the other equipment, or move the AM antenna.</p>
Noise is output when scanning a DTS CD.	<p>This is not a malfunction of the receiver. The scan function of your player alters the digital information, making it unreadable, resulting in noise being output. Lower the volume when scanning.</p>
When playing a DTS format LD there is audible noise on the soundtrack.	<p>Make sure that the input signal type is set to <b>DIGITAL</b> (see <a href="#">Choosing the input signal</a> on page 54).</p>
Subwoofer output is very low.	<p>To route more signal to the subwoofer, set it to <b>PLUS</b> or set the front speakers to <b>SMALL</b> (see <a href="#">Speaker Setting</a> on page 89).</p>
Everything seems to be set up correctly, but the playback sound is odd.	<p>The speakers may be out of phase. Check that the positive/negative speaker terminals on the receiver are matched with the corresponding terminals on the speakers (see <a href="#">Connecting the speakers</a> on page 21).</p>
The Phase Control feature doesn't seem to have an audible effect.	<p>If applicable, check that the lowpass filter switch on your subwoofer is off, or the lowpass cutoff is set to the highest frequency setting. If there is a PHASE setting on your subwoofer, set it to 0° (or depending on the subwoofer, the setting where you think it has the best overall effect on the sound).</p> <p>Make sure the speaker distance setting is correct for all speakers (see <a href="#">Speaker Distance</a> on page 90).</p>
Noise or hum can be heard even when there is no sound being input.	<p>Check that personal computers or other digital components connected to the same power source are not causing interference.</p>
Can't select some Input functions by the <b>INPUT SELECTOR</b> on the front panel or the <b>INPUT SELECT</b> button on the remote control.	<p>Check the <b>Input Skip</b> settings in the <b>Input Setup</b> menu (see <a href="#">The Input Setup menu</a> on page 40).</p> <p>Check the <b>HDMI Input</b> assignment in the <b>Input Setup</b> menu then try <b>OFF</b> (see <a href="#">The Input Setup menu</a> on page 40).</p>
There seems to be a time lag between the speakers and the output of the subwoofer.	<p>See <a href="#">Automatically conducting optimum sound tuning (Full Auto MCACC)</a> on page 38 to set up your system again using MCACC (this will automatically compensate for a delay in the subwoofer output).</p>
The maximum volume available (shown in the front panel display) is lower than the <b>+12dB</b> maximum.	<p>Check that the <b>Volume Limit</b> is set to <b>OFF</b> (see <a href="#">Volume Setup</a> on page 93).</p> <p>The channel level setting may be over <b>0.0dB</b>.</p>
Certain listening modes or <b>HOME MENU</b> items cannot be selected.	<p>When <b>Operation Mode</b> is set to <b>Basic</b>, the Pioneer-recommended settings are made and not all of the functions can be used. To use all of the functions without restrictions, set <b>Operation Mode</b> to <b>Expert</b> (see <a href="#">Operation Mode Setup</a> on page 41).</p> <p>Some functions cannot be selected, depending on the input signal and listening mode.</p>



Symptom	Remedy
The volume level drops automatically.	The temperature within the unit has exceeded the allowable value. Try moving the unit for better ventilation (see <a href="#">Installing the receiver</a> on <a href="#">page 10</a> ).
Volume seems different when input is switched.	Set the <b>Channel Level</b> setting to <b>ALL</b> , then adjust the volume of the respective input sources (see <a href="#">Input Volume Absorber</a> on <a href="#">page 71</a> ).
When <b>HDZONE</b> is <b>ON</b> , multi-channel audio sources are not output in the main zone.	When <b>HDZONE</b> is selected in <b>Speaker System</b> and also the same HDMI input is selected for both the main zone and HDZONE, 2-channel PCM audio sources are output from the main zone as well. To output multi-channel audio sources, set <b>HDZONE</b> to <b>OFF</b> or change the HDZONE input.

## ADAPTER PORT terminal

Symptom	Remedy
The <i>Bluetooth</i> wireless technology device cannot be connected or operated. Sound from the <i>Bluetooth</i> wireless technology device is not emitted or the sound is interrupted.	<p>Check that no object that emits electromagnetic waves in the 2.4 GHz band (microwave oven, wireless LAN device or <i>Bluetooth</i> wireless technology apparatus) is near the unit. If such an object is near the unit, set the unit far from it. Or, stop using the object emitting the electromagnetic waves.</p> <p>Check that the <i>Bluetooth</i> wireless technology device is not too far from the unit and that obstructions are not set between the <i>Bluetooth</i> wireless technology device and the unit. Set the <i>Bluetooth</i> wireless technology device and the unit so that the distance between them is less than about 10 m (33 ft.) and no obstructions exist between them.</p> <p>Check that the <i>Bluetooth</i> ADAPTER and the <b>ADAPTER PORT</b> of the unit are correctly connected.</p> <p>The <i>Bluetooth</i> wireless technology device may not be set to the communication mode supporting the <i>Bluetooth</i> wireless technology. Check the setting of the <i>Bluetooth</i> wireless technology device.</p> <p>Check that pairing is correct. The pairing setting was deleted from this unit or the <i>Bluetooth</i> wireless technology device. Reset the pairing.</p> <p>Check that the profile is correct. Use a <i>Bluetooth</i> wireless technology device that supports A2DP profile and AVRCP profile.</p>
<b>ADT OVERLOAD</b> is displayed on the display.	<p>There is a problem in the power supply for the <i>Bluetooth</i> adapter. After turning OFF the power of the receiver, disconnect the <i>Bluetooth</i> adapter and insert the <i>Bluetooth</i> adapter again, then turn ON the power of the receiver.</p> <p>If <b>ADT OVERLOAD</b> is displayed even though the above operation is repeated several times, there is a problem with the receiver or the <i>Bluetooth</i> adapter. Disconnect the power cable and request repair.</p>

## Video

Symptom	Remedy
No image is output when an input is selected.	<p>Check the video connections of the source component.</p> <p>For HDMI, or when <b>V.CONV</b> is set to <b>OFF</b> and a TV and another component are connected with different cords (in <a href="#">Setting the Video options</a> on <a href="#">page 69</a>), you must connect your TV to this receiver using the same type of video cable as you used to connect your video component. For the component video input, however, signals are only output from the HDMI output, so when using the component video input, set <b>V.CONV</b> to <b>ON</b>.</p> <p>Make sure the input assignment is correct for components connected using component video or HDMI cables (see <a href="#">The Input Setup menu</a> on <a href="#">page 40</a>).</p> <p>Check the video output settings of the source component.</p> <p>Check that the video input you selected on your TV is correct.</p> <p>Some components (such as video game units) have resolutions that may not be converted. If adjusting this receiver's Resolution setting (in <a href="#">Setting the Video options</a> on <a href="#">page 69</a>) and/or the resolution settings on your component or display doesn't work, try switching <b>V.CONV</b> (in <a href="#">Setting the Video options</a> on <a href="#">page 69</a>) to <b>OFF</b>.</p> <p>When the <b>HDMI OUT 1/2</b> setting of the output parameter function is set to <b>OFF</b>, set it to <b>ON</b>.</p> <p>When the network function or <b>iPod/USB</b> input is selected in HDZONE, video connected with the video cable or component cable is not output from the HDMI terminal. To output video, turn off HDZONE or set HDZONE to some other input (<a href="#">page 72</a>).</p>
Noisy, intermittent, or distorted picture.	Sometimes a video deck may output a noisy video signal (during scanning, for example), or the video quality may just be poor (with some video game units, for example). The picture quality may also depend on the settings, etc. of your display device. Switch off the video converter and reconnect the source and display device using the same type of connection (component or composite), then start playback again.
The picture's movement is unnatural.	When Resolution under <b>VIDEO PARAMETER</b> is set to <b>1080/24p</b> or <b>4K/24p</b> , the picture may not be displayed properly for some source materials. In this case, set the resolution to something other than 1080/24p or 4K/24p ( <a href="#">page 69</a> ).
Video parameters cannot be used.	<p>For audio only input (TUNER, CD, and TV), the video parameter function cannot be used. Use for video or input with a GUI display.</p> <p>Cannot be used when the HDZONE is ON. Turn OFF the HDZONE.</p>



## Settings

Symptom	Remedy
The Auto MCACC Setup continually shows an error.	<p>The ambient noise level may be too high. Keep the noise level in the room as low as possible (see also <a href="#">Problems when using the Auto MCACC Setup</a> on <a href="#">page 39</a>). If the noise level cannot be kept low enough, you will have to set up the surround sound manually (<a href="#">page 89</a>).</p> <p>When using only one surround back speaker, connect it to the <b>SURROUND BACK L (Single)</b> terminals.</p> <p>To use a 5.1-channel speaker set, use the surround speakers for the surround channel, not the surround back channel.</p> <p>Make sure there are no obstacles between the speakers and the microphone.</p> <p>If <b>Reverse Phase</b> is displayed, try the following:</p> <ul style="list-style-type: none"> <li>— The speaker's wiring (+ and -) may be inverted. Check the speaker connections.</li> <li>— Depending on the type of speakers and their installation conditions, <b>Reverse Phase</b> may be displayed even if the speakers are properly connected. If this happens, select <b>GO NEXT</b> and continue.</li> <li>— If the speaker is not pointed to the microphone (listening position) or when using speakers that affect the phase (dipole speakers, reflective speakers, etc.), it may not be possible to properly identify the polarity.</li> </ul>
After using the Auto MCACC Setup, the speaker size setting is incorrect.	<p>There may have been some low frequency noise in the room from an air-conditioner, motor, etc. Switch off all other appliances in the room and use Auto MCACC Setup again.</p> <p>Depending on a number of factors (bass reproduction capabilities of the speakers, room size, speaker placement, etc.) this may occur in some cases. Change the speaker setting manually in <a href="#">Speaker Setting</a> on <a href="#">page 89</a>, and use the <b>ALL (Keep SP System)</b> option for the <b>Auto MCACC</b> menu in <a href="#">Automatic MCACC (Expert)</a> on <a href="#">page 82</a> if this is a recurring problem.</p>
Can't adjust the Fine Speaker Distance setting properly.	Check that the speakers are all in phase (make sure the positive (+) and negative (-) terminals are matched up properly).
The display shows <b>KEY LOCK ON</b> when you try to make settings.	With the receiver in standby, press <b>⏻ STANDBY/ON</b> for about 5 seconds while holding down <b>SPEAKERS</b> to disable the key lock.
Most recent settings have been erased.	<p>The power cord was disconnected from the wall while adjusting this setting.</p> <p>Settings are only stored if all the zones are turned off. Turn off all the zones before unplugging the power cord.</p>
The various system settings are not stored.	Do not pull out the power cord while conducting the settings. (The settings will be stored when both the main zone and sub zone turn off. Turn off all zones before pulling out the power cord.)
Certain listening modes or <b>HOME MENU</b> items cannot be selected.	When <b>Operation Mode</b> is set to <b>Basic</b> , the Pioneer-recommended settings are made and not all of the functions can be used. To use all of the functions without restrictions, set <b>Operation Mode</b> to <b>Expert</b> (see <a href="#">Operation Mode Setup</a> on <a href="#">page 41</a> ).
Feels like there is no subwoofer EQ effect.	The effect becomes less when the set frequency value of the crossover frequency is low. When setting a high frequency value, the subwoofer EQ effect becomes stronger. However, setting a higher crossover frequency increases the share that the subwoofer bears for low-frequency playback. For that reason, it is disadvantageous in terms of the phase point of view. Set to your preference.

## Professional Calibration EQ graphical output

Symptom	Remedy
The reverb characteristics graph after EQ calibration does not appear entirely flat.	<p>There are cases where the graph does not appear flat (even when selecting <b>ALL CH ADJ</b> in the Auto MCACC Setup) due to adjustments made to compensate for room characteristics to achieve optimal sound.</p> <p>Areas of the graph may appear identical (before and after) when there is little or no adjustment needed.</p> <p>The graph may appear to have shifted vertically when comparing before and after measurements.</p>
EQ adjustments made using the Manual MCACC setup do not appear to change the reverb characteristics graph after EQ calibration.	Despite level adjustments being made, the filters used for analysis may not display these adjustments in the reverb characteristics graph after EQ calibration. However, these adjustments are taken into account by the filters dedicated to overall system calibration.
Lower frequency response curves do not seem to have been calibrated for <b>SMALL</b> speakers.	<p>Low frequencies used in bass management (the subwoofer channel) will not change for speakers that have been specified as <b>SMALL</b> in the configuration, or do not output these frequencies.</p> <p>Calibration is performed, but due to your speakers' low frequency limitations, no measurable sound is output for display.</p>

## Display

Symptom	Remedy
The display is dark or off.	Press <b>DIMMER</b> repeatedly to select a different brightness.
The OSD screen is not displayed.	<p>The on-screen display is not displayed unless the receiver's <b>HDMI OUT 1</b> terminal and the TV are connected with an HDMI cable. If the TV does not support HDMI, perform the operations and make the settings watching the display on the receiver's front panel.</p> <p>When the input is a 3D signal, OSD cannot be displayed.</p>
Even though the input is switched, <b>DIGITAL</b> does not light.	Check the digital connections and make sure that the digital inputs are assigned correctly (see <a href="#">The Input Setup menu</a> on <a href="#">page 40</a> ).
<b>DIGITAL</b> or <b>DTS</b> does not light when playing Dolby/DTS software.	<p>These indicators do not light if playback is paused.</p> <p>Make sure that the receiver is set to <b>AUTO</b> or <b>DIGITAL</b> (see <a href="#">Choosing the input signal</a> on <a href="#">page 54</a>).</p> <p>Check the playback (especially the digital output) settings of the source component.</p>
When playing Dolby Digital or DTS sources, the receiver's format indicators do not light.	<p>Check that the player is connected using a digital connection.</p> <p>Make sure that the receiver is set to <b>AUTO</b> or <b>DIGITAL</b> (see <a href="#">Choosing the input signal</a> on <a href="#">page 54</a>).</p> <p>Check that the player isn't set up so that Dolby Digital and DTS sources are converted to PCM.</p> <p>Ensure that if there are several audio tracks on the disc, the Dolby Digital or DTS is selected.</p>
When playing certain discs, none of the receiver's format indicators light.	<p>The disc may not contain multi-channel material. Check the disc packaging for more on what audio tracks are recorded on the disc.</p> <p>It does not light when the PCM signal or analog signal is input.</p>



Symptom	Remedy
When playing a disc with the listening mode set to Auto Surround or ALC, <b>Pro Logic II</b> or <b>DTS Neo:X</b> does not appear on the receiver.	Make sure that the receiver is set to <b>AUTO</b> or <b>DIGITAL</b> (see <a href="#">Choosing the input signal</a> on <a href="#">page 54</a> ). If a two channel soundtrack is currently playing (including Dolby Surround encoded), then this is not a malfunction. Check the disc packaging for details about the audio tracks available.
During playback of DVD-Audio, the display shows <b>PCM</b> .	This will occur when playing DVD-Audio material over the HDMI connection. This is not a malfunction.
The power turns off automatically and some indicator flashes, or some indicator flashes and the power does not turn on.	See the <b>Power</b> section ( <a href="#">page 98</a> ).

## Remote control

Symptom	Remedy
Cannot be remote controlled.	Set the remote control unit's remote control mode so that it matches the setting on the main unit (see <a href="#">Operating multiple receivers</a> on <a href="#">page 76</a> ). Check whether the receiver's remote control mode is properly set (see <a href="#">Remote Control Mode Setup</a> on <a href="#">page 93</a> ). Try replacing the batteries in the remote control (see <a href="#">Loading the batteries</a> on <a href="#">page 10</a> ). Be sure to operate within 7 m (23 ft.) and a 30° angle of the remote sensor on the front panel (see <a href="#">Operating range of remote control unit</a> on <a href="#">page 11</a> ). Check that there are no obstacles between the receiver and the remote control. Make sure that there is no fluorescent or other strong light shining on to the remote sensor.
Other components can't be operated with the system remote.	If the battery ran down, the preset codes may have been cleared. Re-enter the preset codes. The preset code may be incorrect. Redo the procedure for entering preset codes. When commands from the remote control units of other devices are registered using the learning function, in some cases they may not be learned properly. In this case, register the commands again using the learning function (see <a href="#">page 77</a> ). If they still do not work, they may be in a special format that cannot be registered on this receiver's remote control. Operate the device using another remote control.

## HDMI

Symptom	Remedy
The <b>HDMI</b> indicator blinks continuously.	Check all the points below.
Video/audio is not output or is interrupted.	This receiver is HDCP-compatible. Check that the components you are connecting are also HDCP-compatible. If they are not, please connect them using the component or composite video jacks. Depending on the connected source component, it's possible that it will not work with this receiver (even if it is HDCP-compatible). In this case, connect using the component or composite video jacks between source and receiver. If the problem still persists when connecting your HDMI component directly to your monitor, please consult the component or monitor manual or contact the manufacturer for support. If video images do not appear on your TV, try adjusting the resolution, Deep Color or other setting for your component. While analog video signals are being output over HDMI, use a separate connection for audio output. To output signals in Deep Color, use an HDMI cable (High Speed HDMI®/™ Cable) to connect this receiver to a component or TV with the Deep Color feature. Influence from a TV whose power is set to standby may cause the picture or sound not to be produced or to be broken. In this case, press <b>OUT P.</b> and switch so that the HDMI output to which that TV is connected is not selected.
No picture.	Try changing the Resolution setting (in <a href="#">Setting the Video options</a> on <a href="#">page 69</a> ). To use the <b>HDMI OUT 2</b> terminal in the main zone, set the <b>MAIN/HDZONE Output Setting</b> to <b>MAIN</b> ( <a href="#">page 94</a> ).
No sound, or sound suddenly ceases.	Check that the HDMI Audio setting is set to <b>AMP</b> ( <a href="#">Setting the Audio options</a> on <a href="#">page 67</a> ). If the component is a DVI device, use a separate connection for the audio. If analog video is being output over HDMI, please use a separate connection for the audio. Check the audio output settings of the source component. HDMI format digital audio transmissions require a longer time to be recognized. Due to this, interruption in the audio may occur when switching between audio formats or beginning playback. Turning on/off the device connected to this unit's <b>HDMI OUT</b> terminal during playback, or disconnecting/connecting the HDMI cable during playback, may cause noise or interrupted audio.
Noisy or distorted picture.	Sometimes a video deck may output a noisy video signal (during scanning, for example), or the video quality may just be poor (with some video game units, for example). The picture quality may also depend on the settings, etc. of your display device. Switch off the video converter and reconnect the source and display device using the same type of connection (component or composite), then start playback again. If the problem still persists when connecting your HDMI component directly to your monitor, please consult the component or monitor manual or contact the manufacturer for support.



Symptom	Remedy
<b>HDCP ERROR</b> shows in the display.	Check whether or not the connected component is compatible with HDCP. If it is not compatible with HDCP, reconnect the source device using a different type of connection (component or composite). Some components that are compatible with HDCP still cause this message to be displayed, but so long as there is no problem with displaying video, this is not a malfunction.
Synchronized operation not possible using <b>Control</b> with HDMI function.	Check the HDMI connections. The cable may be damaged. Select <b>ON</b> for the <b>Control Mode</b> with HDMI setting (see <a href="#">HDMI Setup</a> on <a href="#">page 63</a> ). Turn the TV's power on before turning on this receiver's power. Set the TV side Control with HDMI setting to on (see TV's operating instructions). Connect the TV to the <b>HDMI OUT 1</b> terminal and set the HDMI output to <b>OUT 1</b> . Then turn on first the TV's power, then this receiver's power.
When <b>HDZONE</b> is set to ON, the video resolution and number of audio channels for the main zone side changes.	This is due to the HDMI connection specifications; it is not a malfunction. When playing the same input in the main zone and <b>HDZONE</b> , video and audio signals that can be output in common for all the devices connected to the <b>HDMI OUT 1</b> , <b>HDMI OUT 2</b> and <b>HDMI OUT 2 (HDZONE)</b> terminals are set.
<b>HDZONE</b> cannot be turned on.	Set <b>Output Setting</b> at <b>MAIN/HDZONE</b> to <b>HDZONE</b> ( <a href="#">page 94</a> ).
When the input source for the main or HDZONE is switched or when the power of the respective zones is turned on and off, the audio or video of the HDMI output terminal that is not being operated is sometimes interrupted.	This is because the HDMI devices need to recognize each other again. This is not a malfunction. If the picture is disturbed or not displayed, turn off the power of the devices in all the zones, then try again. Also try temporarily turning the <b>Network Standby</b> and <b>Standby Through</b> settings <b>OFF</b> .
Such menus as the <b>HOME MENU</b> as well as the on-screen display are not displayed for <b>HDMI OUT 1</b> .	Press <b>OUT P</b> , and switch the HDMI OUT 1/2 setting.
Cannot upscale to 4K or 1080p.	Change <b>V.CONV</b> to <b>ON</b> . ( <a href="#">page 69</a> ) Change <b>RES</b> . ( <a href="#">page 69</a> ) When the network function or <b>iPod/USB</b> input is selected using HDZONE, upscaling cannot be performed. To perform upscaling, turn off HDZONE or set HDZONE to some other input ( <a href="#">page 72</a> ).
4K video is not output even though a 4K compliant TV is connected.	When the <b>MAIN/HDZONE</b> setting is <b>MAIN</b> and the HDMI output setting is <b>OUT 1+2</b> and when the <b>MAIN/HDZONE</b> setting is <b>HDZONE</b> and HDZONE is the same input as with the main zone, video is output with the lower resolution of the TV connected to <b>HDMI OUT 1</b> and <b>HDMI OUT 2</b> . When there is only one 4K compliant TV, connect it to <b>HDMI OUT 1</b> and set the HDMI output setting to <b>OUT 1</b> or turn off HDZONE so that video is only output to the 4K compliant TV.

## MHL

Symptom	Remedy
When playing an MHL-compatible device connected to the <b>HDMI 6/MHL</b> terminal, the Standby Through function does not work and the power turns off.	The MHL device will not operate unless power is being supplied from this receiver. When this receiver is in the Standby Through mode, power cannot be supplied due to reduced power consumption. Because of this, the MHL device will not operate. This is not a malfunction. Set <b>ROKU Standby Mode</b> of the receiver to <b>ON</b> to use an MHL-compatible device.
MHL-compatible device cannot be operated with the remote control.	Press <b>MHL</b> to set the remote control to the MHL control mode.
<b>MHL POW ERR</b> is displayed on the display.	There is a problem with the power supply for the MHL device. After turning OFF the receiver, disconnect the MHL device, connect the MHL device again and then turn ON the power of the receiver. If the error is displayed even though the above operation is repeated several times, there is a problem with the receiver or the MHL device. Disconnect the power cable and request repair.

## Built-in AVNavigator

Symptom	Cause	Remedy
AVNavigator does not interact well with the receiver.	The receiver's power is not turned on. The receiver or computer is not connected to the LAN. The router's power is off.	Turn the receiver's power on. (Wait about 60 seconds after the power turns on for network functions to start.) Connect a LAN cable to the receiver or computer ( <a href="#">page 32</a> ). Turn the router's power on.
In the middle of <b>Wiring Navi</b> , you are instructed to turn off the power of the unit and then connect other equipment or speakers.	Network connections could be restricted due to the computer's network settings, security settings, etc.	Check the computer's network settings, security settings, etc.
When the <b>Wiring Navi</b> or <b>Interactive Operation Guide</b> is launched, a warning about security protection appears on the browser.	This is to avoid failure of the receiver due to a short-circuit between cables or from static electricity.	Per the <b>Wiring Navi</b> instructions, turn OFF the power of the receiver. As long as the browser has not quit, <b>Wiring Navi</b> resumes guidance upon turning ON the receiver.
When the <b>Wiring Navi</b> or <b>Interactive Operation Guide</b> is launched, a warning about security protection appears on the browser.	This is because of the browser's security function.	This is not a problem. Perform the operation to authorize the blocked contents.
AVNavigator screen is not displayed on the browser.	This receiver's IP address has not been entered into the browser correctly.	Check the receiver's IP address and enter it correctly in the browser ( <a href="#">page 92</a> ).
Receiver settings cannot be made from a browser.	JavaScript is disabled on the internet browser. The browser is not compatible with JavaScript.	Enable JavaScript. Use an internet browser that is compatible with JavaScript.





## USB interface

Symptom	Cause	Remedy
The folders/files stored on a USB memory device are not displayed.	The folders/files are currently stored in a region other than the FAT (File Allocation Table) region.	Store the folders/files in the FAT region.
	The number of levels in a folder is more than 9.	Limit the maximum number of levels in a folder to 9 ( <a href="#">page 46</a> ).
	The audio files are copyrighted.	Copyrighted audio files stored on a USB memory device cannot be played back ( <a href="#">page 46</a> ).
A USB memory device is not recognized.	The USB memory device does not support the mass storage class specifications.	Try using a USB memory device compatible with the mass storage class specifications. Note that there are cases where even the audio files stored on a USB memory device compatible with the mass storage class specifications are not played back on this receiver ( <a href="#">page 46</a> ).
	A USB hub is currently being used.	This receiver does not support USB hubs ( <a href="#">page 46</a> ).
	This receiver recognizes the USB memory device as a fraud.	Switch off and on again this receiver. Reconnect the USB device with the receiver switched off. Change to an input other than iPod/USB, then set the input back to iPod/USB.
A USB memory device is connected and displayed, but the audio files stored on the USB memory device cannot be played back.	Some formats of USB memory devices, including FAT 12, NTFS, and HFS, cannot be played back on this receiver.	Check whether the format of your USB memory device is either FAT 16 or FAT 32. Note that the FAT 12, NTFS, and HFS formats cannot be played back on this receiver ( <a href="#">page 46</a> ).
	The file format cannot be properly played back on this receiver.	See the list of file formats that can be played back on this receiver ( <a href="#">page 47</a> ).
The USB memory cannot be operated with the remote control.	—	Press <b>iPod USB</b> to set the remote control to the iPod USB control mode.
<b>Over Current</b> shows in the display.	—	There is a problem with the power supply for the USB memory. After turning off the receiver, disconnect the USB memory, connect the USB memory again and then turn on the power of the receiver. If <b>Over Current</b> is displayed even though the above operation is repeated several times, there is a problem with the receiver or USB memory. Disconnect the power cable and request repair.

## iPod

Symptom	Cause	Remedy
iPod is not recognized.	This receiver recognizes the iPod as a fraud.	Switch off and on again this receiver. Reconnect the iPod with the receiver switched off. Change to an input other than iPod/USB, then set the input back to iPod/USB.
iPod touch/iPhone is not recognized or otherwise does not operate properly.	The iPod's operation may be unstable.	Try performing the operation below. 1. Press the sleep/sleep cancel button on the iPod touch/iPhone simultaneously with the home button for at least 10 seconds to restart the device. 2. Turn this receiver's power on. 3. Connect the iPod touch/iPhone to this receiver.
iPod cannot be operated with the remote control.	—	Press <b>iPod USB</b> to set the remote control to the iPod USB control mode.

## Network

Symptom	Cause	Remedy
Cannot access the network.	The LAN cable is not firmly connected.	Firmly connect the LAN cable ( <a href="#">page 32</a> ).
	The router is not switched on.	Switch on the router.
	Internet security software is currently installed in the connected component.	There are cases where a component with Internet security software installed cannot be accessed.
	The audio component on the network which has been switched off is switched on.	Switch on the audio component on the network before switching on this receiver.
Playback does not start while " <b>Connecting...</b> " continues to be displayed.	The component is currently disconnected from this receiver or the power supply.	Check whether the component is properly connected to this receiver or the power supply.
The network function cannot be operated with the remote control.	—	Press <b>NET</b> to set the remote control to the network function control mode.
The PC or Internet radio is not properly operated.	The corresponding IP address is not properly set.	Switch on the built-in DHCP server function of your router, or set up the network manually according to your network environment ( <a href="#">page 91</a> ).
	The IP address is being automatically configured.	The automatic configuration process takes time. Please wait.





Symptom	Cause	Remedy
The audio files stored on components on the network, such as a PC, cannot be played back.	Windows Media Player 11 or Windows Media Player 12 is not currently installed on your PC.	Install Windows Media Player 11 or Windows Media Player 12 on your PC ( <a href="#">page 56</a> ).
	Audio files recorded in MPEG-4 AAC or FLAC are being played back on Windows Media Player 11 or Windows Media Player 12.	Audio files recorded in MPEG-4 AAC or FLAC cannot be played back on Windows Media Player 11 or Windows Media Player 12. Try using another server. Refer to the operation manual supplied with your server.
	The component connected to the network is not properly operated.	Check whether the component is affected by special circumstances or is in the sleep mode. Try rebooting the component if necessary.
	The component connected to the network does not permit file sharing.	Try changing the settings for the component connected to the network.
	The folder stored on the component connected to the network has been deleted or damaged.	Check the folder stored on the component connected to the network.
	Network connections could be restricted due to the computer's network settings, security settings, etc.	Check the computer's network settings, security settings, etc.
	Supported file formats vary by server. As such, files not supported by your server are not displayed on this unit.	For more information check with the manufacturer of your server.
	The audio files are copyrighted.	DRM-protected audio files cannot be played back on this receiver.
Cannot access the component connected to the network.	The component connected to the network is not properly set.	If the client is automatically authorized, you need to enter the corresponding information again. Check whether the connection status is set to "Do not authorize".
	There are no playable audio files on the component connected to the network.	Check the audio files stored on the component connected to the network.

Symptom	Cause	Remedy
Audio playback is undesirably stopped or disturbed.	The audio file currently being played back was not recorded in a format playable on this receiver.	Check whether the audio file was recorded in a format supported by this receiver. Check whether the folder has been damaged or corrupted. Note that there are cases where even the audio files listed as playable on this receiver cannot be played back or displayed ( <a href="#">page 61</a> ).
	The LAN cable is currently disconnected.	Connect the LAN cable properly ( <a href="#">page 32</a> ).
	There is heavy traffic on the network with the Internet being accessed on the same network.	Use 100BASE-TX to access the components on the network.
	When in the DMR mode, depending on the external controller being used, playback may be interrupted when a volume operation is performed from the controller.	In this case, adjust the volume from the receiver or remote control.
	There is a connection routed through a wireless LAN on the same network.	There may be a shortage of bandwidth on the 2.4 GHz band used by the wireless LAN. Make wired LAN connections not routed through a wireless LAN.
		Install away from any devices emitting electromagnetic waves on the 2.4 GHz band (microwave ovens, game consoles, etc.). If this does not solve the problem, stop using other devices that emit electromagnetic waves.
Cannot access Windows Media Player 11 or Windows Media Player 12.	<i>In case of Windows Media Player 11:</i> You are currently logged onto the domain through your PC with Windows XP or Windows Vista installed.	Instead of logging onto the domain, log onto the local machine ( <a href="#">page 57</a> ).
	<i>In case of Windows Media Player 12:</i> You are currently logged onto the domain through your PC with Windows 7 or Windows 8 installed.	
Cannot listen to Internet radio stations.	The firewall settings for components on the network are currently in operation.	Check the firewall settings for components on the network.
	You are currently disconnected from the Internet.	Check the connection settings for components on the network, and consult with your network service provider if necessary ( <a href="#">page 91</a> ).
	The broadcasts from an Internet radio station are stopped or interrupted.	There are cases where you cannot listen to some Internet radio stations even when they are listed in the list of Internet radio stations on this receiver ( <a href="#">page 57</a> ).
This unit cannot be selected from the Spotify application.	—	An Internet connection is required for both the mobile device and this unit.
		Connect the mobile device by Wi-Fi to the wireless LAN router of the same network as the one to which this unit is connected.
		A Spotify Premium account (for a charge) must be registered on the Spotify application. When this unit is in standby, it cannot be selected from the Spotify application.



Symptom	Cause	Remedy
The sound of the Spotify audio stream is not produced.	—	<p>Check whether this unit is selected on the Spotify application.</p> <p>Check that contents are playing on the Spotify application.</p> <p>If the above does not solve the problem, turn this unit's power off then back on.</p>
	With an AV receiver that has the <b>'System Setup' → 'Other Setup' → 'Play ZONE Setup'</b> option, the sound may be playing in another zone.	If this is the case, set which zone the sound is to be played in at the play zone settings.
This unit's volume does not increase when the volume slider in the Spotify application is raised.	A volume upper limit is provided so that the volume will not inadvertently go up too much.	<p>To further increase the volume, use the remote control.</p> <p>When the iControlAV5 or built-in AVNavigator application is being used, you can use the application to increase the volume.</p>
Playback continues on this unit when the Spotify application is quit.	The Spotify audio stream continues from this unit, even when the Spotify application is quit.	To operate again, relaunch the Spotify application.
The Network functions cannot be operated with the buttons on the remote control.	The remote control is not currently set to the Network function mode.	Press <b>NET</b> to set the remote control to the Network function mode ( <a href="#">page 57</a> ).
When the DMR mode or AirPlay is used from a computer, smartphone, etc., the sound is played in <b>ZONE 2</b> .	<b>Play ZONE Setup</b> is set to <b>ZONE 2</b> .	Change <b>Play ZONE Setup</b> to <b>MAIN</b> ( <a href="#">page 94</a> ).
Network connections cannot be made via the wireless LAN converter (AS-WL300).	—	For details, see <a href="#">Wireless LAN</a> on <a href="#">page 107</a> .



## Wireless LAN

### Network cannot be accessed via wireless LAN.

Wireless LAN converter's power is not on. (Wireless LAN converter's "Power", "WPS" and "Wireless" indicators are not all lit.)

- Check that the USB cable connecting the wireless LAN converter to the receiver's **DC OUTPUT for WIRELESS LAN** terminal is properly connected.

**WLAN POW ERR** is displayed on the receiver's display window.

- There is a problem with the wireless LAN converter's power supply. Turn the receiver's power off, then disconnect the USB cable, reconnect the USB cable and turn the receiver's power back on.
- If **WLAN POW ERR** is still displayed after repeating the above procedure several times, there is a problem with the receiver or the USB cable. Unplug the receiver from the wall and call a Pioneer authorized independent service company.

The LAN cable is not firmly connected.

- Firmly connect the LAN cable ([page 34](#)).

Wireless LAN converter and base unit (wireless LAN router, etc.) are too far apart or there is an obstacle between them.

- Improve the wireless LAN environment by moving the wireless LAN converter and base unit closer together, etc.

There is a microwave oven or other device generating electromagnetic waves near the wireless LAN environment.

- Use the system in a place away from microwave ovens or others device generating electromagnetic waves.
- Avoid using devices generating electromagnetic waves as much as possible when using the system with the wireless LAN.

Multiple wireless LAN converters are connected to the wireless LAN router.

- When connecting multiple wireless LAN converters, their IP addresses must be changed.

Wireless LAN connections cannot be established between the wireless LAN converter and base unit (wireless LAN router, etc.).

- The wireless LAN converter must be set in order to establish wireless LAN connections. For details, see the CD-ROM included with the wireless LAN converter.

The IP address settings of the receiver and wireless LAN converter do not match the settings of the wireless LAN router, etc.

- Check the IP address settings of the receiver and wireless LAN converter (including the DHCP setting). If the receiver's DHCP setting is "ON", turn the receiver's power off, then turn the power back on. Check that the IP addresses of the receiver and wireless LAN converter match the settings of the wireless LAN router, etc.

If the receiver's DHCP setting is "OFF", set an IP address matching the network of the base unit (wireless LAN router, etc.).

For example, if the wireless LAN router's IP address is "192.168.1.1", set the receiver's IP address to "192.168.1.XXX" (\*1), the subnet mask to "255.255.255.0", the gateway and DNS to "192.168.1.1".

Next, set the wireless LAN converter's IP address to "192.168.1.249" (\*2).

(\*1) Set the "XXX" in "192.168.1.XXX" to a number between 2 and 248 that is not assigned to other devices.

(\*2) Set the "249" in "192.168.1.249" to a number between 2 and 249 that is not assigned to other devices.

Try making the wireless LAN converter's advanced settings.

- The wireless LAN converter can be connected to a computer to make the advanced wireless LAN settings. For details, see the CD-ROM included for the wireless LAN converter. Check the settings of the wireless LAN router, etc., then change the settings of the wireless LAN converter. Note, however, that making the advanced wireless LAN settings will not necessarily improve the wireless LAN environment. Be careful when changing the settings.

The access point is set to conceal the SSID.

- In this case, the SSID may not be displayed on the access point list screen. If not, set the SSID, etc., by making the wireless LAN converter settings on the receiver manually.

The access point's security settings use WEP 152-bit length code key or shared key authentication.

- The receiver does not support WEP 152-bit length code key or shared key authentication.

Network connections cannot be established even when the above measures are taken.

- Reset the wireless LAN converter. After this, redo the wireless LAN converter's settings.  
About resetting
  1. Check that the wireless LAN converter's power is on.
  2. Press the wireless LAN converter's reset button for at least 3 seconds.
  3. Release the reset button.

When the wireless LAN converter is restarted, the resetting procedure is completed.



## Additional information

Surround sound formats.....	109
SABRE DAC™ .....	109
About HDMI .....	109
HTC Connect.....	109
About iPod .....	110
Windows 8 .....	110
MHL.....	110
Software license notice.....	110
Auto Surround, ALC and Stream Direct with different input signal formats.....	111
Speaker Setting Guide .....	111
About messages displayed when using network functions.....	112
Important information regarding the HDMI connection .....	113
Cleaning the unit .....	113
Glossary .....	113
Features index.....	116
Specifications .....	117
Preset code list .....	118



## Surround sound formats

Below is a brief description of the main surround sound formats you'll find on BDs, DVDs, satellite, cable and terrestrial broadcasts, and video cassettes.

### Dolby

The Dolby technologies are explained below. See <http://www.dolby.com> for more detailed information.



*Manufactured under license from Dolby Laboratories. Dolby, Pro Logic, Surround EX, and the double-D symbol are trademarks of Dolby Laboratories.*

### DTS

The DTS technologies are explained below. See <http://www.dts.com> for more detailed information.



*For DTS patents, see <http://patents.dts.com>. Manufactured under license from DTS Licensing Limited. DTS, DTS-HD, the Symbol, & DTS and the Symbol together are registered trademarks, and DTS-HD Master Audio is a trademark of DTS, Inc. © DTS, Inc. All Rights Reserved.*



*For DTS patents, see <http://patents.dts.com>. Manufactured under license from DTS Licensing Limited. DTS, the Symbol, & DTS and the Symbol together are registered trademarks, and DTS Neo:X | 7.1 is a trademark of DTS, Inc. © DTS, Inc. All Rights Reserved.*

## SABRE DAC™

*SABRE DAC™ and the logo are trademarks of ESS Technology, Inc.*

### About HDMI

HDMI (High-Definition Multimedia Interface) is a digital transfer standard for receiving video and audio data with a single cable. It is an adaptation of DVI (Digital Visual Interface), a display connection technology, for use in home audio devices. This interface standard is for next-generation TVs providing High-bandwidth Digital Content Protection (HDCP).



*The terms HDMI and HDMI High-Definition Multimedia Interface, and the HDMI Logo are trademarks or registered trademarks of HDMI Licensing, LLC in the United States and other countries.*

## HTC Connect



HTC, HTC Connect and the HTC Connect logo are trademarks of HTC Corporation.



## About iPod



AirPlay works with iPhone, iPad, and iPod touch with iOS 4.3.3 or later, Mac with OS X Mountain Lion, and Mac and PC with iTunes 10.2.2 or later.

USB works with iPhone 5s, iPhone 5c, iPhone 5, iPhone 4s, iPhone 4, iPhone 3GS, iPhone 3G, iPhone, iPod touch (1st through 5th generation) and iPod nano (3rd through 7th generation).

"Made for iPod" and "Made for iPhone" mean that an electronic accessory has been designed to connect specifically to iPod or iPhone, respectively, and has been certified by the developer to meet Apple performance standards. Apple is not responsible for the operation of this device or its compliance with safety and regulatory standards. Please note that the use of this accessory with iPod or iPhone may affect wireless performance.

*Apple, AirPlay, iPad, iPhone, iPod, iPod nano, iPod touch, iTunes, Safari, Bonjour, Mac, Mac OS and OS X are trademarks of Apple Inc., registered in the U.S. and other countries.*

*The AirPlay logo is a trademark of Apple Inc.*

*App Store is a service mark of Apple Inc.*

## Windows 8

This product is Windows 8.1 Compatible and Windows 8 Compatible.



*Windows® and the Windows logo are trademarks of the Microsoft group of companies.*

## MHL



*MHL, the MHL Logo, and Mobile High-Definition Link are trademarks or registered trademarks of MHL, LLC in the United States and other countries.*

## Software license notice

### About Apple Lossless Audio Codec

Copyright © 2011 Apple Inc. All rights reserved.

Licensed under the Apache License, Version 2.0. You may obtain a copy of the License at <http://www.apache.org/licenses/LICENSE-2.0>

### About FLAC

#### FLAC Decoder

Copyright © 2000, 2001, 2002, 2003, 2004, 2005, 2006, 2007, 2008, 2009

Josh Coalson

Redistribution and use in source and binary forms, with or without modification, are permitted provided that the following conditions are met:

- Redistributions of source code must retain the above copyright notice, this list of conditions and the following disclaimer.
- Redistributions in binary form must reproduce the above copyright notice, this list of conditions and the following disclaimer in the documentation and/or other materials provided with the distribution.
- Neither the name of the Xiph.org Foundation nor the names of its contributors may be used to endorse or promote products derived from this software without specific prior written permission.

THIS SOFTWARE IS PROVIDED BY THE COPYRIGHT HOLDERS AND CONTRIBUTORS "AS IS" AND ANY EXPRESS OR IMPLIED WARRANTIES, INCLUDING, BUT NOT LIMITED TO, THE IMPLIED WARRANTIES OF MERCHANTABILITY AND FITNESS FOR A PARTICULAR PURPOSE ARE DISCLAIMED. IN NO EVENT SHALL THE FOUNDATION OR CONTRIBUTORS BE LIABLE FOR ANY DIRECT, INDIRECT, INCIDENTAL, SPECIAL, EXEMPLARY, OR CONSEQUENTIAL DAMAGES (INCLUDING, BUT NOT LIMITED TO, PROCUREMENT OF SUBSTITUTE GOODS OR SERVICES; LOSS OF USE, DATA, OR PROFITS; OR BUSINESS INTERRUPTION) HOWEVER CAUSED AND ON ANY THEORY OF LIABILITY, WHETHER IN CONTRACT, STRICT LIABILITY, OR TORT (INCLUDING NEGLIGENCE OR OTHERWISE) ARISING IN ANY WAY OUT OF THE USE OF THIS SOFTWARE, EVEN IF ADVISED OF THE POSSIBILITY OF SUCH DAMAGE.



## Auto Surround, ALC and Stream Direct with different input signal formats

The following charts show what you will hear with different input signal formats, depending on the Stream Direct mode (see [Using Stream Direct](#) on [page 53](#)) you have selected.

### Stereo (2 channel) signal formats

Input signal format	Auto Surround / ALC / DIRECT	PURE DIRECT
<b>Surround Back speaker(s): Connected</b>		
Dolby Digital Surround	<input checked="" type="checkbox"/> Pro Logic IIx MOVIE	<input checked="" type="checkbox"/> Pro Logic IIx MOVIE
DTS Surround	Neo:X CINEMA	Neo:X CINEMA
Other stereo sources	Stereo playback	Stereo playback
Analog sources	As above	ANALOG DIRECT (stereo)
PCM sources	As above	Stereo playback
DVD-A sources	As above	As above
SACD sources	As above	As above
<b>Surround Back speaker(s): Not connected</b>		
Dolby Digital Surround	<input checked="" type="checkbox"/> Pro Logic II MOVIE	<input checked="" type="checkbox"/> Pro Logic II MOVIE
DTS Surround	Neo:X CINEMA	Neo:X CINEMA
Other stereo sources	Stereo playback	Stereo playback
Analog sources	As above	ANALOG DIRECT (stereo)
PCM sources	As above	Stereo playback
DVD-A sources	As above	As above
SACD sources	As above	As above

### Multichannel signal formats

Input signal format	Auto Surround / ALC	PURE DIRECT / DIRECT
<b>Surround Back speaker(s): Connected</b>		
Dolby Digital EX (6.1 channel flagged) Dolby TrueHD EX (6.1 channel flagged)	Dolby Digital EX <input checked="" type="checkbox"/> Pro Logic IIx MOVIE <a>	Dolby Digital EX <input checked="" type="checkbox"/> Pro Logic IIx MOVIE <a>
DTS-HD Master Audio ES (6.1 channel flagged)	DTS-ES (Matrix)	DTS-ES (Matrix)
DTS-ES (6.1 channel sources/6.1 channel flagged)	DTS-ES (Matrix/Discrete)	DTS-ES (Matrix/Discrete)
DTS sources (5.1 channel encoding)	Straight decoding	Straight decoding
DTS-HD sources	As above	As above
Other 5.1/6.1/7.1 channel sources	As above	As above
<b>Surround Back speaker(s): Not connected</b>		
DVD-A sources/Multi-ch PCM	Straight decoding	Straight decoding
SACD sources (5.1 channel encoding)	As above	As above
Other 5.1/6.1/7.1 channel sources	As above	As above

a Unavailable with only one surround back speaker connected.

## Speaker Setting Guide

In order to achieve an even better surround effect, it is important to accurately position the speakers and make their volume and tone characteristics uniform so as to finely focus the multi-channel sound.

The three major elements in positioning the speakers are **distance**, **angle** and **orientation** (the direction in which the speakers are pointing).

**Distance:** The distance of all the speakers should be equal.

**Angle:** The speakers should be horizontally symmetrical.

**Orientation:** The orientation should be horizontally symmetrical.

In most homes, however, it is not possible to achieve this environment. For the distance, on this receiver it is possible to automatically correct the speaker distance electrically to a precision of 1 cm (0.4 inch) using the Full Auto MCACC Setup function ([page 38](#)).

### Step 1: Speaker layout and distance adjustment

Use speaker stands or the like to make sure the speakers are steady, and leave at least 10 cm (4 inches) from the surrounding walls. Position the speakers attentively so that the speakers on the left and right are at equal angles from the listening position (center of the adjustments). (We recommend using cords, etc., when adjusting the layout.) Ideally all the speakers should be equidistant from the listening position.



#### Note

If the speakers cannot be set at equal distances (on a circle), use the Auto MCACC Setup speaker distance correction and Fine Speaker Distance functions to make them equalize the distance artificially.

### Step 2: Adjusting the speaker height

Adjust the heights (angles) of the different speakers.

Adjust so that the front speaker units reproducing mid- and high frequencies is roughly at the height of the ears. If the center speaker cannot be set at the same height as the front speakers, adjust its angle of elevation to point it to the listening position.

Set surround speaker 1 so that it is not under the height of the ears.

### Step 3: Adjusting the speaker orientation

If the left and right speakers are not pointing in the same direction, the tone will not be the same on the right and left, and as a result the sound field will not be reproduced properly. However, if all the speakers are pointed towards the listening position, the sound field will seem cramped. Testing by the Pioneer Multi-channel Research Group has shown that a good sense of sound positioning can be achieved by pointing all the speakers towards an area 30 cm (12 inches) to 80 cm (31 inches) behind the listening position (between the surround speakers and the listening position).

However, the sense of sound positioning can differ according to the conditions in the room and the speakers being used. In smaller environments in particular (when the front speakers are close to the listening position), with this method the speakers will be pointed too inward. We suggest you use this example of installation as reference when trying out different installation methods.

### Step 4: Positioning and adjusting the subwoofer

Placing the subwoofer between the center and front speakers makes even music sources sound more natural (if there is only one subwoofer, it doesn't matter if it is placed on the left or right side). The low bass sound output from the subwoofer is not directional and there is no need to adjust the height. Normally the subwoofer is placed on the floor. Put it in a position at which it will not cancel out the bass sound output from the other speakers.



Also note that placing it near a wall may result in sympathetic vibrations with the building that could excessively amplify the bass sound.

If the subwoofer must be installed near a wall, place it at an angle so that it is not parallel to the wall surface. This can help reduce any sympathetic vibrations, but depending on the shape of the room this could result in standing waves. However, even if standing waves are generated, their influence on the sound quality can be prevented using the Auto MCACC's standing wave control function (page 85).

### Step 5: Default settings with the Auto MCACC Setup (auto sound field correction) function

It is more effective to perform the Full Auto MCACC Setup (page 38) procedure once the adjustments described above have been completed.



#### Note

The distance to the subwoofer may be slightly larger than the distance actually measured with a tape measure, etc. This is because this distance is corrected for electric delay, and is not a problem.

### Positional relationship between speakers and monitor

#### Position of front speakers and monitor

The front speakers should be as equidistant as possible to the monitor.

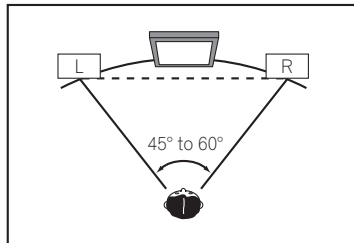

#### Position of center speaker and monitor

Since mostly dialogs are output from the center speaker, keeping the center speaker as close as possible to the screen makes the overall sound more natural. For TVs using Braun tubes, however, when installing the center speaker on the floor, adjust its angle of elevation to point it towards the listening position.

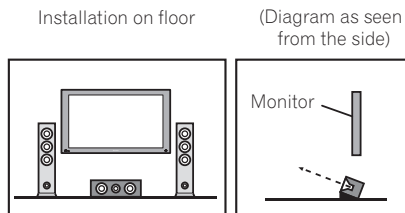

- If the center speaker is not of the shielded type, install it away from the TV.
- When installing the center speaker on top of the monitor, place it facing slightly downwards towards the listening position.

### About messages displayed when using network functions

Refer to the following information when you come up with a status message while operating the Network functions.

Status messages	Descriptions
Connection Down	The selected category or Internet radio station cannot be accessed.
File Format Error	Cannot be played back for some reasons.
Track Not Found	The selected song has not been found anywhere on the network.
Server Error	The selected server cannot be accessed.
Server Disconnected	The server has been disconnected.
Empty	There are no files stored in the selected folder.
License Error	The license for the contents to be played back is invalid.
Item Already Exists	This is displayed when the file you have attempted to register in the Favorites folder has already been registered.
Favorite List Full	This is displayed when you have attempted to register a file in the Favorites folder but the Favorites folder is already full.





## Important information regarding the HDMI connection

There are cases where you may not be able to route HDMI signals through this receiver (this depends on the HDMI-equipped component you are connecting-check with the manufacturer for HDMI compatibility information).

If you aren't receiving HDMI signals properly through this receiver (from your component), please try one of the following configurations when connecting up.

### Configuration A

Use component video cables to connect the video output of your HDMI-equipped component to the receiver's component video input. The receiver can then convert the analog component video signal to a digital HDMI signal for transmission to the display. For this configuration, use the most convenient connection (digital is recommended) for sending audio to the receiver. See the operating instructions for more on audio connections.



#### Note

The picture quality will change slightly during conversion.

### Configuration B

Connect your HDMI-equipped component directly to the display using an HDMI cable. Then use the most convenient connection (digital is recommended) for sending audio to the receiver. See the operating instructions for more on audio connections. Set the display volume to minimum when using this configuration.



#### Notes

- If your display only has one HDMI terminal, you can only receive HDMI video from the connected component.
- Depending on the component, audio output may be limited to the number of channels available from the connected display unit (for example audio output is reduced to 2 channels for a monitor with stereo audio limitations).
- If you want to switch the input function, you'll have to switch functions on both the receiver and your display unit.
- Since the sound is muted on the display when using the HDMI connection, you must adjust the volume on the display every time you switch input functions.

## Cleaning the unit

- Use a polishing cloth or dry cloth to wipe off dust and dirt.
- When the surface is dirty, wipe with a soft cloth dipped in some neutral cleanser diluted five or six times with water, and wrung out well, and then wipe again with a dry cloth. Do not use furniture wax or cleansers.
- Never use thinners, benzene, insecticide sprays or other chemicals on or near this unit, since these will corrode the surface.

## Glossary

### Audio formats/Decoding

#### Dolby

The Dolby technologies are explained below. See <http://www.dolby.com> for more detailed information.

#### Dolby Digital

Dolby Digital is a multichannel digital audio coding system widely used in cinemas, and in the home for DVD and digital broadcast soundtracks.

#### Dolby TrueHD

Dolby TrueHD is the lossless encoding technology developed for high-definition optical discs in the upcoming era.

#### Dolby Digital Plus

Dolby Digital Plus is the audio technology for all high-definition programming and media. It combines the efficiency to meet future broadcast demands with the power and flexibility to realize the full audio potential expected in the upcoming high-definition era.

#### Dolby Digital Surround EX

Dolby Digital Surround EX (the EX stands for EXtended) is an extension of Dolby Digital encoding whereby a surround back channel is matrixed into the surround left/right channels for 6.1 channel playback. This allows for compatibility with Dolby Digital 5.1 channel decoding, as well as for decoding using Dolby Digital EX.

#### Dolby Pro Logic IIx and Dolby Surround

Dolby Pro Logic IIx is an improved version of the Dolby Pro Logic II (and Dolby Pro Logic) decoding system. Dolby Surround is an encoding system which embeds surround sound information within a stereo soundtrack, which a Dolby Pro Logic decoder can then use for enhanced surround listening with greater sound detail.

#### Dolby Pro Logic IIz

Adding a pair of speakers above the front left and right speakers adds expressiveness in the vertical direction to the previous horizontally-oriented sound field. The height channel strengthens the sound field's sense of three-dimensionality and air, producing presence and expansion.

#### DTS

The DTS technologies are explained below. See <http://www.dts.com> for more detailed information.

#### DTS Digital Surround

DTS Digital Surround is a 5.1-channel audio coding system from DTS Inc. now widely used for DVD-Video, DVD-Audio, 5.1 music discs, digital broadcasts, and video games.

#### DTS-HD Master Audio

DTS-HD Master Audio is a technology that delivers master audio sources recorded in a professional studio to listeners without any loss of data, preserving audio quality.

#### DTS-HD High Resolution Audio

A high definition audio technology by which signals can be transferred over HDMI cables.

#### DTS-ES

DTS-ES (the ES stands for Extended Surround) is a decoder that is capable of decoding both DTS-ES Discrete 6.1 and DTS-ES Matrix 6.1 encoded sources.

#### DTS Neo:X

DTS Neo:X can generate 11.1 channel surround sound from any matrixed stereo source (such as video or TV) and from 5.1 channel sources.



## Decoding

A technology for converting digital signals that have been compressed upon recording by a digital signal processing circuit, etc., into the original signals. The term "decoding" (or "matrix decoding") is also used for the technology which converts 2-channel sound sources into multiple channels or expands 5.1-channel signals into 6.1 or 7.1 channels.

## Calibrating the sound field/Improving the sound quality

### Phase Control

The Phase Control technology incorporated into this receiver's design provides coherent sound reproduction through the use of phase matching for an optimal sound image at your listening position.

### Virtual Speakers

Virtual playback of a maximum of 11.2 channels combining the actually installed speakers and the virtual speakers is possible. This makes for smoother connection between the sounds and an improved 3D feel.

### Virtual Surround Back

When you're not using surround back speakers, selecting this mode allows you to hear a virtual surround back channel through your surround speakers. You can choose to listen to sources with no surround back channel information.

### Virtual Height

When you're not using front height speakers, selecting this mode allows you to hear a virtual front height channel through your front speakers.

### Virtual Wide

When you're not using front wide speakers, selecting this mode allows you to hear a virtual front wide channel through your front speakers.

### Virtual Depth

When this mode is selected, the sound field expands virtually to behind the display, resulting in a sound field with the same depth as the 3D picture to achieve a better sense of presence.

### Auto Sound Retriever

The Auto Sound Retriever feature employs DSP technology to restore sound pressure and smooth jagged artifacts left over after compression.

With some audio inputs, the Sound Retriever effect is automatically optimized based on the bitrate information of the contents that have been input to achieve high sound quality.

### Sound Retriever Air

Sound Retriever Air compensates for reduced sound quality due to compression when sending *Bluetooth* signals.

### PQLS

Jitterless high quality playback is possible by connecting a PQLS-compatible player with HDMI connections.

### ALC (Auto Level Control)

In the Auto level control (ALC) mode, this receiver equalizes playback sound levels.

Also, the low and high frequency sounds, dialogs, surround effects, etc., that are difficult to hear when the volume is low are adjusted to be optimal for the volume level. This mode is particularly optimum when listening at night.

### Front Stage Surround Advance

With the Front Stage Surround Advance feature, you can enjoy seamless, natural surround sound effects using only the front speakers, without deteriorating the quality of the original sound.

### MCACC

The Auto MCACC Setup provides a quick but accurate surround sound setup, which includes the advanced features of Professional Acoustic Calibration EQ.

## HDMI

### Control with HDMI function

Synchronized operations below with a **Control** with HDMI-compatible Pioneer TV or Blu-ray Disc player are possible when the component is connected to the receiver using an HDMI cable.

- The receiver's volume can be set and the sound can be muted using the TV's remote control.
- The receiver's input switches over automatically when the TV's input is changed or a **Control** with HDMI-compatible component is played.
- The receiver's power is also set to standby, when the TV's power is set to standby.

### ARC (Audio Return Channel)

When a TV supporting the HDMI ARC (Audio Return Channel) function is connected to the receiver, the sound of the TV can be input via the **HDMI OUT** terminal.

The sound of the TV can be input from the receiver's **HDMI OUT** terminal, so connection with the TV can be completed with a single HDMI cable.

## Network function

### AirPlay

AirPlay works with iPhone, iPad, and iPod touch with iOS 4.3.3 or later, Mac with OS X Mountain Lion, and Mac and PC with iTunes 10.2.2 or later.

For more information, see the Apple website (<http://www.apple.com>).

### DLNA

The Digital Living Network Alliance (DLNA) is a cross-industry organization of consumer electronics, computing industry and mobile device companies. Digital Living provides consumers with easy sharing of digital media through a wired or wireless network in the home.

### vTuner

vTuner is a paid online database service that allows you to listen to radio and TV broadcasts on the Internet.

vTuner lists thousands of stations from over 100 different countries around the globe. For more detail about vTuner, visit the following website:

<http://www.radio-pioneer.com>

*"This product is protected by certain intellectual property rights of NEMS and BridgeCo. Use or distribution of such technology outside of this product is prohibited without a license from NEMS and BridgeCo or an authorized subsidiary."*

### Apple Lossless (ALAC)

"ALAC" stands for Apple Lossless Audio Codec. This is a lossless type audio codec and is used for example for iTunes®. It compresses non-compressed files (such as WAV and AIFF) to about one half the original size with no loss of sound quality.

### FLAC

FLAC (Free Lossless Audio Codec) is an audio format allows lossless codec. Audio is compressed in FLAC without any loss in quality. For more details about FLAC, visit the following website:

<http://flac.sourceforge.net/>

### Windows Media

Windows Media is a multimedia framework for media creation and distribution for Microsoft Windows. Windows Media is either a registered trademark or trademark of Microsoft Corporation in the U.S. and/or other countries.

Use an application licensed by Microsoft Corporation to author, distribute, or play Windows Media formatted content. Using an application unauthorized by Microsoft Corporation is subject to malfunction.



**Windows Media Player 11/Windows Media Player 12**

Windows Media Player is software to deliver music, photos and movies from a Microsoft Windows computer to home stereo systems and TVs.

With this software, you can play back files stored on the PC through various devices wherever you like in your home.

This software can be downloaded from Microsoft's website.

- Windows Media Player 11 (for Windows XP or Windows Vista)
- Windows Media Player 12 (for Windows 7 or Windows 8)

For more information check the official Microsoft website.

**Router**

A device for relaying data flowing on a network to another network. In homes, routers often also function as DHCP servers. Products with built-in wireless LAN access points are called "wireless LAN routers".

**DHCP**

Abbreviation of Dynamic Host Configuration Protocol. A protocol for automatically assigning such setting information as IP addresses within network connections. This offers convenience in that, when enabled, it allows network functions to be used simply by connecting the devices to the network.

**Wireless LAN/Wi-Fi**

"Wi-Fi" (Wireless Fidelity) is a trademark coined by the Wi-Fi Alliance trade association to increase recognition of wireless LAN standards. With the increase in the number of devices connected to computers in recent years, Wi-Fi offers the advantage of eliminating the complexity of making connections with LAN cables by using wireless connection. As a way of reassuring users, products that have passed interoperability tests carry the logo "Wi-Fi Certified" to indicate that compatibility is assured.

**WPS**

Abbreviation of Wi-Fi Protected Setup. A standard established by the Wi-Fi Alliance industry group for a function allowing settings related to interconnection of WPS-compatible wireless LAN devices and encryption to be made with simple operations. There are a number of methods, including push-button configuration and PIN code configuration. This AV receiver supports both push-button configuration and PIN code configuration.

**SSID**

Abbreviation of Service Set Identifier. A wireless LAN access point identifier. Can be set as desired using up to 32 characters of English letters and numbers.

**Bluetooth function****Bluetooth wireless technology**

A short-range wireless communications standard for digital devices. Information is exchanged between devices several meters to several tens of meters apart using radio waves. It uses radio waves on the 2.4 GHz band which does not require applications for licenses or usage registration for applications conducting wireless exchange of digital information at relatively low speeds, such as computer mouses and keyboards, mobile phones, smartphones, text and audio information for PDAs, etc.

**Pairing**

"Pairing" must be done before you start playback of *Bluetooth* wireless technology content using the *Bluetooth* ADAPTER. Make sure to perform pairing the first time you operate the system or any time pairing data is cleared. The pairing step is necessary to register the *Bluetooth* wireless technology device to enable *Bluetooth* communications. For more details, see also the operating instructions of your *Bluetooth* wireless technology device.

- Pairing is required when you first use the *Bluetooth* wireless technology device and *Bluetooth* ADAPTER.
- To enable *Bluetooth* communication, pairing should be done with both your system and *Bluetooth* wireless technology device.

**Receiver function****Operation Mode**

This receiver is equipped with a great number of functions and settings. The Operation Mode feature is provided for users who find it difficult to master all these functions and settings.

**MHL**

MHL (Mobile High-definition Link) is an interface standard for transmitting digital signals with mobile devices. MHL can carry high quality multi-channel audio data and 3D/Full-HD video formats.

"This receiver incorporates MHL 2."



## Features index

### Operation Mode

See [Operation Mode Setup](#) on [page 41](#).

### AVNavigator

See [How to use the built-in AVNavigator](#) on [page 37](#).

### ECO MODE 1, 2

See [Using the Advanced surround effects](#) on [page 53](#).

### HDZONE

See [MULTI-ZONE setup](#) on [page 30](#).

### HTC Connect

See [About HTC Connect](#) on [page 57](#).

### Pandora

See [Listening to Pandora Internet Radio](#) on [page 58](#).

### Play ZONE

See [Play ZONE Setup](#) on [page 94](#).

### 4K pass through/up scaling

See [About HDMI](#) on [page 24](#).

### Full Auto MCACC

See [Automatically conducting optimum sound tuning \(Full Auto MCACC\)](#) on [page 38](#).

### Automatic MCACC (Expert)

See [Automatic MCACC \(Expert\)](#) on [page 82](#).

### Manual MCACC setup

See [Manual MCACC setup](#) on [page 84](#).

### PQLS

See [Setting the PQLS function](#) on [page 64](#).

### Phase Control

See [Better sound using Phase Control](#) on [page 54](#).

### Standing Wave

See [Setting the Audio options](#) on [page 67](#).

### Phase Control Plus

See [Setting the Audio options](#) on [page 67](#).

### Auto Sound Retriever

See [Setting the Audio options](#) on [page 67](#).

### ALC (Auto Level Control)

See [Auto playback](#) on [page 52](#).

### Front Stage Surround Advance

See [Enjoying various types of playback using the listening modes](#) on [page 52](#).

### Sound Retriever Air

See [Enjoying various types of playback using the listening modes](#) on [page 52](#).

### Dialog Enhancement

See [Setting the Audio options](#) on [page 67](#).

### Internet radio

See [Listening to Internet radio stations](#) on [page 57](#).

### vTuner

See [Listening to Internet radio stations](#) on [page 57](#).

### DLNA

See [About network playback](#) on [page 60](#).

### AirPlay

See [Using AirPlay on iPod touch, iPhone, iPad, and iTunes](#) on [page 56](#).

### Wireless LAN

See [Connecting to a wireless LAN](#) on [page 34](#).

### Playback High Resolution audio file

See [About playable file formats](#) on [page 61](#).

See [Playing a USB device](#) on [page 46](#).

### Slideshow

See [Playing back photo files stored on a USB memory device](#) on [page 46](#).

### Bluetooth ADAPTER

See [Bluetooth ADAPTER for Wireless Enjoyment of Music](#) on [page 49](#).

### ARC (Audio Return Channel)

See [HDMI Setup](#) on [page 63](#).

### Auto delay

See [Setting the Audio options](#) on [page 67](#).

### Height Gain (Dolby Pro Logic IIz Height option)

See [Setting the Audio options](#) on [page 67](#).

### Virtual Surround Back

See [Setting the Audio options](#) on [page 67](#).

### Virtual Height

See [Setting the Audio options](#) on [page 67](#).

### Virtual Wide

See [Setting the Audio options](#) on [page 67](#).

### Virtual Depth

See [Setting the Audio options](#) on [page 67](#).

### Digital Video Converter

See [Setting the Video options](#) on [page 69](#).

### Pure Cinema

See [Setting the Video options](#) on [page 69](#).

### Progressive Motion

See [Setting the Video options](#) on [page 69](#).

### Advanced Video Adjust

See [Setting the Video options](#) on [page 69](#).

### Auto Power Down

See [The Other Setup menu](#) on [page 92](#).



## Specifications

### Amplifier section

**Continuous average power output of 90 watts\* per channel, min., at 8 ohms, from 20 Hz to 20 000 Hz with no more than 0.08 %\*\* total harmonic distortion.**

Front (stereo).....	90 W + 90 W
Power output (1 kHz, 6 $\Omega$ , 1 %, 1 ch driven) .....	165 W
Guaranteed speaker impedance.....	6 $\Omega$ to 16 $\Omega$

\* Measured pursuant to the Federal Trade Commission's Trade Regulation rule on Power Output Claims for Amplifiers

\*\* Measured by Audio Spectrum Analyzer

\*\* Measured by Audio Spectrum Analyzer

### Audio Section

Input (Sensitivity/Impedance)

LINE .....	315 mV/47 k $\Omega$
Signal-to-Noise Ratio (IHF, short circuited, A network)	
LINE .....	100 dB
Signal-to-Noise Ratio [EIA, at 1 W (1 kHz)]	
LINE .....	81 dB

### Tuner Section

Frequency Range (FM) .....	87.5 MHz to 108 MHz
Antenna Input (FM).....	75 $\Omega$ unbalanced
Frequency Range (AM).....	530 kHz to 1 700 kHz
Antenna (AM) .....	Loop antenna (balanced)

### Video Section

Signal level

Composite Video.....	1 Vp-p (75 $\Omega$ )
Component Video .....	Y: 1.0 Vp-p (75 $\Omega$ ), PB/PR: 0.7 Vp-p (75 $\Omega$ )
Corresponding maximum resolution	
Component Video .....	1080p (1125p)

### Digital In/Out Section

HDMI terminal .....	19-pin (Not DVI)
HDMI output type.....	5 V, 100 mA
HDMI input/MHL terminal .....	5 V, 900 mA
USB terminal.....	USB2.0 High Speed (Type A) 5 V, 1 A
iPod terminal.....	USB
ADAPTER PORT terminal.....	5 V, 100 mA
WIRELESS LAN ADAPTER terminal .....	5 V, 600 mA

### Integrated Control Section

Control (IR) terminal .....	$\emptyset$ 3.5 Mini-jack (MONO)
IR signal.....	High Active (High Level: 2.0 V)

### Network Section

LAN terminal .....	10 BASE-T/100 BASE-TX
--------------------	-----------------------

### Miscellaneous

Power requirements .....	AC 120 V, 60 Hz
Power consumption.....	.550 W
In standby.....	0.1 W
Dimensions .....	435 mm (W) x 168 mm (H) x 363 mm (D) (17 3/16 in. (W) x 6 5/8 in. (H) x 14 5/16 in. (D))
Weight (without package) .....	9.8 kg (21 lb 10 oz)

### Number of Furnished Parts

MCACC Setup microphone .....	1
Remote control unit.....	1
AAA size IEC R03 dry cell batteries.....	2
AM loop antenna.....	1
FM wire antenna .....	1
CD-ROM	
Quick start guide	
Safety Brochure	
Warranty sheet	



### Notes

- Specifications and the design are subject to possible modifications without notice, due to improvements.
- This product includes FontAvenue® fonts licensed by NEC Corporation. FontAvenue is a registered trademark of NEC Corporation.
- iOS is a trademark on which Cisco holds the trademark right in the US and certain other countries.
- Microsoft, Windows, Windows Media and Windows Vista are either registered trademarks or trademarks of Microsoft Corporation in the United States and/or other countries.
- Android and Google Play are trademarks of Google Inc.
- Corporation and product names mentioned herein are trademarks or registered trademarks of the respective corporations.



## Preset code list

You should have no problem controlling a component if you find the manufacturer in this list, but please note that there are cases where codes for the manufacturer in the list will not work for the model that you are using. There are also cases where only certain functions may be controllable after assigning the proper preset code.



### Important

- We do not guarantee the operations of all the manufacturers and devices listed. Operation may not be possible even if a preset code is entered.

If you can't find a preset code that matches the component you want to control, you can still teach the remote individual commands from another remote control (see [Programming signals from other remote controls on page 77](#)).

<b>Pioneer</b> 0004, 0006, 0113, 0233, 0252, 0275, 0291, 0305	<b>Concerto</b> 0004, 0006	<b>GFM</b> 0080, 0084	<b>Luxman</b> 0004, 0006	<b>Sylvania</b> 0004, 0006, 0049, 0079, 0080, 0100, 0101, 0103
<b>Admiral</b> 0001, 0014	<b>Contec</b> 0104	<b>Gibraltar</b> 0004, 0011, 0099, 0100	<b>LXI</b> 0000, 0006, 0101, 0102	<b>Symphonic</b> 0008, 0041, 0103, 0104
<b>Adventura</b> 0012	<b>Contec/Cony</b> 0007, 0008	<b>Goldstar</b> 0004, 0005, 0006, 0007, 0100	<b>Magnavox</b> 0004, 0006, 0019, 0020, 0037, 0042, 0100, 0101	<b>Syntax</b> 0054
<b>Aiwa</b> 0002	<b>Craig</b> 0008, 0104	<b>Gradiente</b> 0066	<b>Majestic</b> 0001	<b>Syntax-Brilliant</b> 0054
<b>Akai</b> 0002, 0100	<b>Crosley</b> 0081, 0101	<b>Grunpy</b> 0008, 0009, 0104	<b>Marantz</b> 0004, 0006, 0062, 0100, 0101	<b>Tandy</b> 0014
<b>Albatron</b> 0097	<b>Crown</b> 0008, 0104	<b>Haier</b> 0112	<b>Megapower</b> 0097	<b>Tatung</b> 0003, 0108
<b>Alleron</b> 0009	<b>CTX</b> 0063	<b>Hallmark</b> 0004, 0006	<b>Megatron</b> 0006	<b>TCL</b> 0308
<b>America Action</b> 0104	<b>Curtis Mathes</b> 0000, 0004, 0006, 0014, 0100, 0101	<b>Harman/Kardon</b> 0101	<b>Memorex</b> 0001, 0005, 0006, 0041	<b>Technics</b> 0010, 0105
<b>Amtron</b> 0008	<b>CXC</b> 0008, 0104	<b>Harvard</b> 0008, 0104	<b>MGA</b> 0004, 0005, 0006, 0100	<b>Techwood</b> 0004, 0006, 0010
<b>Anam</b> 0104	<b>Cytron</b> 0093	<b>Havermy</b> 0014	<b>Midland</b> 0010, 0011, 0099	<b>Teknika</b> 0001, 0004, 0005, 0006, 0007, 0008, 0009, 0101, 0104
<b>Anam National</b> 0003, 0008	<b>Daewoo</b> 0004, 0005, 0006, 0023	<b>Hewlett Packard</b> 0053	<b>Mintek</b> 0091	<b>TMK</b> 0004, 0006
<b>AOC</b> 0004, 0005, 0006, 0100	<b>Daytron</b> 0004, 0006	<b>Hisense</b> 0069	<b>Mitsubishi</b> 0004, 0005, 0006, 0014, 0045	<b>TNCi</b> 0099
<b>Apex</b> 0021, 0102, 0106	<b>Dell</b> 0073	<b>Hitachi</b> 0004, 0006, 0007	<b>Monivision</b> 0097	<b>Toshiba</b> 0026, 0028, 0036, 0038, 0040, 0043, 0102
<b>Audiovox</b> 0008, 0104	<b>DiamondVision</b> 0096	<b>Hyundai</b> 0098	<b>Montgomery Ward</b> 0001	<b>Vector Research</b> 0100
<b>Aventura</b> 0103	<b>Dimensia</b> 0000	<b>Ilo</b> 0089, 0091	<b>Motorola</b> 0003, 0014	<b>Vidikron</b> 0101
<b>Axion</b> 0094	<b>Disney</b> 0046	<b>IMA</b> 0008	<b>MTC</b> 0004, 0005, 0006, 0100	<b>Vidtech</b> 0004, 0005, 0006
<b>Bang &amp; Olufsen</b> 0111	<b>Dumont</b> 0004, 0011, 0099	<b>Infinity</b> 0101	<b>Multitech</b> 0008, 0104, 0110	<b>Viewsonic</b> 0058, 0107
<b>Belcor</b> 0004	<b>Durabrand</b> 0041, 0103, 0104	<b>InFocus</b> 0074	<b>NAD</b> 0006, 0102	<b>Viking</b> 0012
<b>Bell &amp; Howell</b> 0001	<b>Dwin</b> 0014	<b>Initial</b> 0091	<b>NEC</b> 0003, 0004, 0005, 0006, 0100	<b>Viore</b> 0089
<b>Benq</b> 0064	<b>Electroband</b> 0002	<b>Insignia</b> 0085, 0086	<b>Net-TV</b> 0107	<b>Vizio</b> 0004, 0070, 0071, 0108
<b>Bradford</b> 0008, 0104	<b>Electrograph</b> 0107	<b>Inteq</b> 0099	<b>Nikko</b> 0006, 0100	<b>Wards</b> 0000, 0001, 0004, 0005, 0006, 0009, 0100, 0101
<b>Brilliant</b> 0109	<b>Electrohome</b> 0002, 0003, 0004, 0006	<b>Janeil</b> 0012	<b>Norcent</b> 0060	<b>Waycon</b> 0102
<b>Brockwood</b> 0004	<b>Element</b> 0082	<b>JBL</b> 0101	<b>Olevia</b> 0048, 0054, 0059	<b>Westinghouse</b> 0047, 0051
<b>Broksonic</b> 0104	<b>Emerson</b> 0004, 0006, 0007, 0008, 0009, 0023, 0103, 0104	<b>JC Penney</b> 0000, 0004, 0005, 0006, 0010	<b>Onwa</b> 0008, 0104	<b>White Westinghouse</b> 0023
<b>Candle</b> 0004, 0006, 0012, 0100	<b>Emprex</b> 0092	<b>JCB</b> 0002	<b>Oppo</b> 0095	<b>Yamaha</b> 0004, 0005, 0006, 0100
<b>Carnivale</b> 0100	<b>Envision</b> 0004, 0006, 0100	<b>Jensen</b> 0004, 0006	<b>Optimus</b> 0105	<b>Zenith</b> 0001, 0004, 0011, 0015, 0099
<b>Carver</b> 0101	<b>Epson</b> 0061	<b>JVC</b> 0007, 0010, 0044	<b>Optoma</b> 0075	
<b>CCE</b> 0110	<b>ESA</b> 0103	<b>Kasho</b> 0002, 0004, 0006	<b>Optonica</b> 0014	
<b>Celebrity</b> 0002	<b>ESA</b> 0103	<b>KEC</b> 0104	<b>Orion</b> 0025	
<b>Celera</b> 0106	<b>Fujitsu</b> 0009	<b>Kenwood</b> 0004, 0006, 0100	<b>Panasonic</b> 0003, 0010, 0017, 0027, 0105, 0114	
<b>Changhong</b> 0106	<b>Funai</b> 0008, 0009, 0103, 0104	<b>KLH</b> 0106		
<b>Citizen</b> 0004, 0006, 0008, 0100	<b>Futuretech</b> 0008, 0104	<b>Kloss Novabeam</b> 0008, 0012		
<b>Clarion</b> 0104	<b>Gateway</b> 0067, 0107, 0108	<b>KTV</b> 0008, 0100, 0104, 0110		
<b>Coby</b> 0056	<b>GE</b> 0000, 0003, 0004, 0006, 0010, 0016, 0039	<b>LG</b> 0005, 0052, 0078, 0097		
<b>Colortyme</b> 0004, 0006		<b>Logik</b> 0001		





**DVD**

If operations are not possible using the preset codes below, you may be able to conduct operations with the preset codes for the **BD, DVR (BDR, HDR)**.

<b>Pioneer</b> 2014, 2197, 2256	<b>Daewoo</b> 2021, 2087	<b>KLH</b> 2070, 2080	<b>Rowa</b> 2071
<b>Accurian</b> 2092	<b>Denon</b> 2026, 2068	<b>Koss</b> 2024, 2069, 2075	<b>Samsung</b> 2009, 2011, 2015, 2031, 2044, 2068
<b>Advent</b> 2072	<b>Desay</b> 2055	<b>Landel</b> 2093	<b>Sansui</b> 2066
<b>Aiwa</b> 2012	<b>DiamondVision</b> 2042	<b>Lasonic</b> 2085	<b>Sanyo</b> 2066, 2083
<b>Akai</b> 2066	<b>Disney</b> 2022	<b>Lennox</b> 2074, 2090	<b>Sharp</b> 2035
<b>Alco</b> 2070	<b>Durabrand</b> 2090	<b>LG</b> 2019, 2051, 2061, 2082, 2087	<b>Sherwood</b> 2063
<b>Allegro</b> 2087	<b>Emerson</b> 2067, 2082, 2091	<b>Liquid Video</b> 2075	<b>Shin Sonic</b> 2086
<b>Amphion MediaWorks</b> 2037	<b>Enterprise</b> 2082	<b>Liteon</b> 2025, 2092	<b>Sonic Blue</b> 2087
<b>AMW</b> 2037	<b>ESA</b> 2053, 2091	<b>Magnavox</b> 2067, 2076, 2091	<b>Sony</b> 2003, 2004, 2010, 2012, 2027, 2046, 2047, 2048
<b>Apex</b> 2002, 2018, 2079, 2080	<b>Fisher</b> 2083	<b>Memorex</b> 2066	<b>Sungale</b> 2054
<b>Apple</b> 2058	<b>Funai</b> 2091	<b>Microsoft</b> 2077	<b>Superscan</b> 2067
<b>Arrgo</b> 2088	<b>GE</b> 2016, 2077, 2080	<b>Mintek</b> 2038, 2080, 2086	<b>Sylvania</b> 2023, 2067, 2091
<b>Arrgo</b> 2088	<b>GFM</b> 2043	<b>Mitsubishi</b> 2020	<b>Symphonic</b> 2023
<b>Aspire</b> 2073	<b>Go Video</b> 2087	<b>Nesa</b> 2080	<b>Teac</b> 2070
<b>Astar</b> 2052	<b>Gradiente</b> 2068	<b>Next Base</b> 2093	<b>Technics</b> 2068
<b>Audiovox</b> 2070	<b>Greenhill</b> 2080	<b>Nexxtech</b> 2056	<b>Theta Digital</b> 2078
<b>Axion</b> 2040	<b>Haier</b> 2094	<b>Onkyo</b> 2076	<b>Toshiba</b> 2001, 2006, 2049, 2066, 2076
<b>Bang &amp; Olufsen</b> 2081	<b>Harman/Kardon</b> 2030, 2084	<b>Oppo</b> 2041, 2057	<b>Trutech</b> 2000
<b>Blaupunkt</b> 2080	<b>Hitachi</b> 2011	<b>Oritron</b> 2069, 2075	<b>Urban Concepts</b> 2076
<b>Blue Parade</b> 2078	<b>Hitek</b> 2079	<b>Panasonic</b> 2005, 2007, 2017, 2032, 2033, 2050, 2068, 2076	<b>US Logic</b> 2086
<b>Boston</b> 2059	<b>iLive</b> 2062	<b>Philips</b> 2045, 2076	<b>Venturer</b> 2070
<b>Broksonic</b> 2066	<b>Ilo</b> 2038	<b>Proceed</b> 2079	<b>Xbox</b> 2077
<b>California Audio Labs</b> 2068	<b>Initial</b> 2038, 2080	<b>Proscan</b> 2077	<b>Yamaha</b> 2005, 2068
<b>CambridgeSoundWorks</b> 2065	<b>Insignia</b> 2036, 2064, 2091	<b>Qwestar</b> 2069	<b>Zenith</b> 2019, 2076, 2082, 2087
<b>CineVision</b> 2087	<b>Integra</b> 2078	<b>RCA</b> 2008, 2016, 2070, 2077, 2078, 2080	
<b>Coby</b> 2029	<b>iSymphony</b> 2060	<b>Regent</b> 2074	
<b>Curtis Mathes</b> 2089	<b>JBL</b> 2084	<b>Rio</b> 2087	
<b>CyberHome</b> 2000, 2088	<b>JVC</b> 2013		
<b>Cytron</b> 2039	<b>Kawasaki</b> 2070		
	<b>Kenwood</b> 2028, 2068		

**BD**

If operations are not possible using the preset codes below, you may be able to conduct operations with the preset codes for the **DVD, DVR (BDR, HDR)**.

<b>Pioneer</b> 2034, 2192, 2255, 2258, 2259, 2260, 2281	<b>JVC</b> 2290, 2291, 2293, 2294, 2295, 2296	<b>Onkyo</b> 2289	<b>Sony</b> 2283, 2284, 2285, 2292
<b>Denon</b> 2310, 2311, 2312	<b>LG</b> 2286, 2287	<b>Panasonic</b> 2277, 2278, 2279	<b>Toshiba</b> 2288, 2262
<b>Hitachi</b> 2307, 2308, 2309	<b>Marantz</b> 2302, 2303	<b>Philips</b> 2280	<b>Yamaha</b> 2297, 2298, 2299
	<b>Mitsubishi</b> 2300, 2301	<b>Samsung</b> 2282	
		<b>Sharp</b> 2304, 2305, 2306	

**DVR (BDR, HDR)**

If operations are not possible using the preset codes below, you may be able to conduct operations with the preset codes for the **DVD, BD**.

<b>Pioneer</b> 2078, 2099, 2107, 2109, 2144, 2193, 2194, 2195, 2196, 2257, 2258, 2259,	2260, 2261, 2264, 2265, 2266, 2270	<b>Sharp</b> 2267, 2275	<b>Toshiba</b> 2274
	<b>Panasonic</b> 2263, 2269	<b>Sony</b> 2268, 2271, 2272, 2273, 2276	

**VCR**

<b>Pioneer</b> 1035, 1108	<b>Garrard</b> 1005	<b>Microsoft</b> 1017	<b>Sanky</b> 1018
<b>ABS</b> 1017	<b>Gateway</b> 1017	<b>Mind</b> 1017	<b>Sansui</b> 1014, 1019
<b>Adventura</b> 1005	<b>GE</b> 1002, 1004	<b>Mitsubishi</b> 1010	<b>Sanyo</b> 1001, 1002
<b>Aiwa</b> 1005	<b>GOI</b> 1029	<b>Motorola</b> 1004	<b>Sears</b> 1001, 1003, 1004
<b>Alienware</b> 1017	<b>Goldstar</b> 1000, 1003	<b>MTC</b> 1002	<b>Sharp</b> 1012
<b>American High</b> 1004	<b>Gradiente</b> 1005	<b>Multitech</b> 1002, 1005	<b>Shogun</b> 1002
<b>Asha</b> 1002	<b>Harley Davidson</b> 1005	<b>NEC</b> 1000, 1001	<b>Singer</b> 1004
<b>Audio Dynamics</b> 1000	<b>Harman/Kardon</b> 1000	<b>Nikko</b> 1003	<b>Sonic Blue</b> 1026
<b>Audiovox</b> 1003	<b>Headquarter</b> 1001	<b>Niveus Media</b> 1017	<b>Sony</b> 1006, 1009, 1017, 1021
<b>Bang &amp; Olufsen</b> 1032	<b>Hewlett Packard</b> 1017	<b>Noblex</b> 1002	<b>Stack</b> 1017
<b>Beaumarck</b> 1002	<b>HNS</b> 1016	<b>Northgate</b> 1017	<b>STS</b> 1004
<b>Bell &amp; Howell</b> 1001	<b>Howard Computers</b> 1017	<b>Olympus</b> 1004	<b>Sylvania</b> 1004, 1005
<b>Calix</b> 1003	<b>HP</b> 1017	<b>Optimus</b> 1003	<b>Symphonic</b> 1005
<b>Candle</b> 1002, 1003	<b>HTS</b> 1029	<b>Orion</b> 1014, 1019	<b>Systemax</b> 1017
<b>Canon</b> 1004	<b>Hughes Network Systems</b> 1016, 1020, 1022, 1023, 1024	<b>Panasonic</b> 1004, 1008	<b>Tagar Systems</b> 1017
<b>Citizen</b> 1002, 1003	<b>Humax</b> 1016, 1020	<b>Philco</b> 1004	<b>Tandy</b> 1001
<b>Colortyme</b> 1000	<b>Hush</b> 1017	<b>Philips</b> 1004, 1011, 1016, 1020, 1022, 1023, 1024, 1025	<b>Tashiko</b> 1003
<b>Craig</b> 1002, 1003	<b>iBUYPOWER</b> 1017	<b>Philips Magnavox</b> 1011	<b>Teac</b> 1005
<b>Curtis Mathes</b> 1000, 1002, 1004	<b>Instant Replay</b> 1004	<b>Pilot</b> 1003	<b>Technics</b> 1004
<b>Cybernex</b> 1002	<b>JC Penney</b> 1000, 1001, 1002, 1003, 1004	<b>Proscan</b> 1030	<b>Teknika</b> 1003, 1004, 1005
<b>CyberPower</b> 1017	<b>JCL</b> 1004	<b>Pulsar</b> 1018	<b>Tivo</b> 1016, 1020, 1021, 1022, 1025
<b>Daewoo</b> 1005	<b>JVC</b> 1000, 1001, 1020, 1029	<b>Quarter</b> 1001	<b>TMK</b> 1002
<b>DBX</b> 1000	<b>Kenwood</b> 1000, 1001	<b>Quartz</b> 1001	<b>Toshiba</b> 1015, 1017, 1028
<b>Dell</b> 1017	<b>Kodak</b> 1003, 1004	<b>Quasar</b> 1004	<b>Totevision</b> 1002, 1003
<b>DIRECTV</b> 1016, 1020, 1022, 1023, 1024, 1027, 1030, 1031	<b>LG</b> 1003	<b>Radio Shack</b> 1003	<b>Touch</b> 1017
<b>Dish Network</b> 1029	<b>Linksys</b> 1017	<b>Radio Shack/Realistic</b> 1001, 1002, 1003, 1004, 1005	<b>UltimateTV</b> 1031
<b>Dishpro</b> 1029	<b>Lloyd's</b> 1005	<b>Radix</b> 1003	<b>Unitech</b> 1002
<b>Durabrand</b> 1018	<b>LXI</b> 1003	<b>Randex</b> 1003	<b>Vector Research</b> 1000
<b>Dynatech</b> 1005	<b>Magnavox</b> 1004, 1018	<b>RCA</b> 1002, 1004, 1007, 1016, 1020, 1022, 1030, 1031	<b>Video Concepts</b> 1000
<b>Echostar</b> 1029	<b>Magnin</b> 1003	<b>Realistic</b> 1001, 1002, 1003, 1004, 1005	<b>Videosonic</b> 1002
<b>Electrohome</b> 1003	<b>Marantz</b> 1000, 1001, 1004	<b>ReplayTV</b> 1026	<b>Viewsonic</b> 1017
<b>Electroponic</b> 1003	<b>Marta</b> 1003	<b>Ricavision</b> 1017	<b>Voodoo</b> 1017
<b>Emerson</b> 1003, 1004, 1005	<b>Media Center PC</b> 1017	<b>Runco</b> 1018	<b>Wards</b> 1002, 1003, 1004, 1005
<b>Expressvu</b> 1029	<b>MEI</b> 1004	<b>Samsung</b> 1002, 1016, 1022, 1024	<b>XR-1000</b> 1004, 1005,
<b>Fisher</b> 1001	<b>Memorex</b> 1001, 1002, 1003, 1004, 1005, 1018, 1019	<b>MGN Technology</b> 1002	<b>Yamaha</b> 1000, 1001
<b>Fuji</b> 1004			<b>Zenith</b> 1013, 1018
<b>Funai</b> 1005			<b>ZT Group</b> 1017

**CD**

<b>Pioneer</b> 5000, 5011, 5070	<b>Kenwood</b> 5020, 5021, 5031	<b>RCA</b> 5013, 5029	<b>Technics</b> 5041
<b>AKAI</b> 5043	<b>Luxman</b> 5049	<b>Roadstar</b> 5052	<b>Victor</b> 5014
<b>Asuka</b> 5045	<b>Marantz</b> 5033	<b>Sharp</b> 5051	<b>Yamaha</b> 5024, 5025, 5038, 5046, 5047
<b>Denon</b> 5019	<b>Onkyo</b> 5017, 5018, 5030, 5050	<b>Sony</b> 5012, 5023, 5026, 5027, 5028, 5039	
<b>Fisher</b> 5048	<b>Panasonic</b> 5036	<b>TEAC</b> 5015, 5016, 5034, 5035, 5037	
<b>Goldstar</b> 5040	<b>Philips</b> 5022, 5032, 5044		
<b>Hitachi</b> 5042			



**Satellite Set Top Box**

<b>Pioneer</b> 6097, 6098, 6325, 6328, 6329	<b>Expressvu</b> 6002, 6004	<b>nfusion</b> 6015	<b>Sony</b> 6062, 6063, 6030
<b>ADB</b> 6035, 6001	<b>Fortec Star</b> 6123, 6023	<b>Nokia</b> 6025, 6026, 6118, 6119, 6121	<b>Star Choice</b> 6032
<b>Akai</b> 6102	<b>Fresat</b> 6014	<b>Pace</b> 6035, 6005, 6030, 6031	<b>Star Trak</b> 6032
<b>Alba</b> 6005, 6011, 6013	<b>Funai</b> 6070	<b>Panarex</b> 6016	<b>TechniSat</b> 6033
<b>Allsat</b> 6102	<b>GE</b> 6111	<b>Panasat</b> 6016, 6022	<b>Thomson</b> 6110, 6111, 6014
<b>Alltech</b> 6011	<b>General Instrument</b> 6032	<b>Panasonic</b> 6008, 6009, 6030	<b>Tivo</b> 6113, 6114, 6115, 6116
<b>Amstrad</b> 6033, 6030, 6044	<b>GOI</b> 6002, 6004	<b>Philips</b> 6002, 6113, 6038, 6054, 6060, 6059, 6102, 6103, 6030, 6114	<b>Toshiba</b> 6038, 6054, 6039
<b>Antron</b> 6013	<b>Grundig</b> 6007, 6030	<b>Primestar</b> 6032	<b>TPS</b> 6041
<b>Asat</b> 6102	<b>Hirschmann</b> 6033	<b>Proscan</b> 6110, 6111	<b>Triasat</b> 6033
<b>Austar</b> 6000, 6045	<b>Hisense</b> 6020	<b>Proton</b> 6020	<b>Ultrasat</b> 6021
<b>Bell ExpressVu</b> 6002, 6003	<b>Hitachi</b> 6038, 6049	<b>RadioShack</b> 6002, 6111, 6032	<b>US Digital</b> 6020
<b>British Sky Broadcasting</b> 6030	<b>Houston</b> 6002	<b>Radix</b> 6036	<b>USDTV</b> 6020
<b>Canal</b> 6105	<b>HTS</b> 6002, 6004	<b>RCA</b> 6002, 6110, 6111, 6113, 6109, 6061, 6114	<b>ViewSat</b> 6048
<b>Chaparral</b> 6034	<b>Hughes Network Systems</b> 6113, 6038, 6054, 6114, 6115, 6116	<b>Saba</b> 6014	<b>Voom</b> 6032
<b>CNS</b> 6001	<b>Hyundai</b> 6016	<b>Sagem</b> 6041, 6120	<b>Zehnder</b> 6101
<b>Coolsat</b> 6021	<b>iLo</b> 6020	<b>Samsung</b> 6070, 6113, 6091, 6043, 6017, 6114, 6093	<b>Zenith</b> 6042, 6069, 6037
<b>Crossdigital</b> 6043	<b>Innova</b> 6059	<b>Sanyo</b> 6046	
<b>Digenius</b> 6104	<b>Jerrold</b> 6032	<b>Sat Cruiser</b> 6015	
<b>Digiwave</b> 6053	<b>Kathrein</b> 6096	<b>Schwaiger</b> 6066	
<b>DirectTV</b> 6070, 6110, 6111, 6062, 6063, 6113, 6008, 6038, 6054, 6069, 6060, 6059, 6043, 6018, 6114, 6115, 6116, 6093	<b>Lava</b> 6053	<b>Siemens</b> 6007, 6036	
<b>Dish Network System</b> 6002, 6089, 6003, 6004	<b>LG</b> 6047, 6018	<b>SKY</b> 6042, 6059, 6030, 6031	
<b>Dishpro</b> 6002, 6089, 6004	<b>Marantz</b> 6102	<b>SM Electronic</b> 6011	
<b>Echostar</b> 6002, 6089, 6036, 6005, 6003, 6004	<b>McIntosh</b> 6032	<b>Smart</b> 6051	
	<b>Mitsubishi</b> 6038	<b>Sonicview</b> 6055, 6107	
	<b>Motorola</b> 6032, 6042		
	<b>NEC</b> 6050, 6131		
	<b>Netsat</b> 6059		
	<b>Next Level</b> 6032		

**Satellite Set Top Box (SAT/PVR Combination)**

<b>Bell ExpressVu</b> 6002, 6003	<b>Dishpro</b> 6002, 6089	<b>Motorola</b> 6032	<b>Star Choice</b> 6032
<b>DirectTV</b> 6070, 6110, 6062, 6113, 6060, 6059, 6114, 6115, 6116	<b>Echostar</b> 6002, 6089, 6003	<b>Philips</b> 6113, 6114	<b>Tivo</b> 6113, 6114, 6115, 6116
<b>Dish Network System</b> 6002, 6089	<b>Expressvu</b> 6002	<b>Proscan</b> 6110	
	<b>Hughes Network Systems</b> 6113, 6114, 6115, 6116	<b>Samsung</b> 6114	
	<b>JVC</b> 6003	<b>Sonicview</b> 6055, 6107	
		<b>Sony</b> 6062	

**Cable Set Top Box**

<b>Pioneer</b> 0297, 6028, 6029, 6095, 6099, 6325, 6328, 6329	<b>Cable One</b> 6074, 6029	<b>Fosgate</b> 6072	<b>Macab</b> 6040
<b>ABC</b> 6122	<b>Cablevision</b> 6074, 6029	<b>General Instrument</b> 6073, 6072, 6122	<b>Mediacom</b> 6074, 6029
<b>Accuphase</b> 6122	<b>Charter</b> 6074, 6029, 6058	<b>Homecast</b> 6024	<b>Memorex</b> 6112
<b>Amino</b> 6077, 6078	<b>Cisco</b> 6029, 6028, 6083	<b>i3 Micro</b> 6077	<b>Motorola</b> 6074, 6073, 6072, 6029, 6122, 6094
<b>Auna</b> 6082	<b>Comcast</b> 6074, 6029, 1982	<b>Insight</b> 6074, 6073, 6029	<b>MTS</b> 6094
<b>BCC</b> 6072	<b>Cox</b> 6074, 6029	<b>Jebsee</b> 6122	<b>Myrio</b> 6077, 6078
<b>Bell &amp; Howell</b> 6122	<b>Digeo</b> 6029, 6058	<b>Jerrold</b> 6073, 6072, 6122	<b>Noos</b> 6040
<b>Bright House</b> 6074, 6029	<b>Director</b> 6073	<b>Knology</b> 6029	
	<b>Emerson</b> 6122		

**Pace** 6074, 6029, 6028, 6106, 6083  
**Panasonic** 6112, 6083  
**Paragon** 6112  
**Penney** 6112  
**Philips** 6012  
**Pulsar** 6112  
**Quasar** 6112

**Regal** 6072  
**Rogers** 6029  
**Runco** 6112  
**Samsung** 6095  
**Scientific Atlanta** 6029, 6028, 6027, 6112  
**Sejin** 6077  
**Shaw** 6074

**Starcom** 6122  
**Stargate** 6122  
**Suddenlink** 6074, 6029  
**Supercable** 6072  
**Time Warner** 6074, 6029, 6058  
**Tivo** 6076  
**Toshiba** 6112

**United Cable** 6072, 6122  
**US Electronics** 6072  
**Videoway** 6112  
**Zenith** 6112

**Cable Set Top Box (Cable/PVR Combination)**

<b>Pioneer</b> 6029, 6325, 6328, 6329	<b>Comcast</b> 6074, 6029, 6083, 6076	<b>Motorola</b> 6074, 6081	<b>Supercable</b> 6072
<b>Amino</b> 6078	<b>Cox</b> 6074, 6029	<b>Myrio</b> 6078	<b>Time Warner</b> 6074, 6029, 6058
<b>Bright House</b> 6074, 6029	<b>Digeo</b> 6081, 6058	<b>Pace</b> 6029	<b>Tivo</b> 6076
<b>Cable One</b> 6074, 6029	<b>Homecast</b> 6024	<b>Panasonic</b> 6083	
<b>Cablevision</b> 6074, 6029	<b>Insight</b> 6074, 6029	<b>Rogers</b> 6029	
<b>Charter</b> 6074, 6029, 6058	<b>Knology</b> 6029	<b>Scientific Atlanta</b> 6029	
<b>Cisco</b> 6029, 6083	<b>Mediacom</b> 6074, 6029	<b>Shaw</b> 6074	
		<b>Suddenlink</b> 6074, 6029	

**CD-R**

**Pioneer** 5001, 5053, 5071  
**Philips** 5054  
**Yamaha** 5055

**Tuner**

**Pioneer** 5060

**Laser Disc Player**

**Pioneer** 5002, 5003

**Cassete Deck**

**Pioneer** 5058, 5059

**Digital Tape**

**Pioneer** 5057

**MD**

**Pioneer** 5056

**Network Audio Player**

**Pioneer** 5063

**Game**

**X-Box** 2313



To register your product, find the nearest authorized service location, to purchase replacement parts, operating instructions, or accessories, please go to one of following URLs :

Pour enregistrer votre produit, trouver le service après-vente agréé le plus proche et pour acheter des pièces de rechange, des modes d'emploi ou des accessoires, reportez-vous aux URL suivantes :

**In the USA/Aux Etats-Unis**

<http://www.pioneerelectronics.com>

**In Canada/Aux Canada**

<http://www.pioneerelectronics.ca>

S018\_B1\_EnFr

© 2014 PIONEER HOME ELECTRONICS CORPORATION.  
All rights reserved.

---

**PIONEER HOME ELECTRONICS CORPORATION**

1-1, Shin-ogura, Saiwai-ku, Kawasaki-shi, Kanagawa 212-0031, Japan

**PIONEER ELECTRONICS (USA) INC.**

P.O. BOX 1540, Long Beach, California 90801-1540, U.S.A. TEL: (800) 421-1404

**PIONEER ELECTRONICS OF CANADA, INC.**

340 Ferrier Street, Unit 2, Markham, Ontario L3R 2Z5, Canada TEL: 1-877-283-5901, 905-479-4411

**PIONEER EUROPE NV**

Haven 1087, Keetberglaan 1, B-9120 Melsele, Belgium TEL: 03/570.05.11

**PIONEER ELECTRONICS ASIACENTRE PTE. LTD.**

253 Alexandra Road, #04-01, Singapore 159936 TEL: 65-6472-7555

**PIONEER ELECTRONICS AUSTRALIA PTY. LTD.**

5 Arco Lane, Heatherton, Victoria, 3202, Australia, TEL: (03) 9586-6300

**PIONEER ELECTRONICS DE MEXICO S.A. DE C.V.**

Blvd.Manuel Avila Camacho 138 10 piso Col.Lomas de Chapultepec, Mexico, D.F. 11000 TEL: 55-9178-4270

K002\_B3\_En

<ARB7552-B>